

UNITED STATES DEPARTMENT OF THE INTERIOR
GEOLOGICAL SURVEY

Technical Reference
Atlantic OCS Region
Minerals Management Service

GEOLOGIC AND OPERATIONAL SUMMARY, COST NO. G-1 WELL,

GEORGES BANK AREA,
NORTH ATLANTIC OCS

OPEN-FILE REPORT 80-268

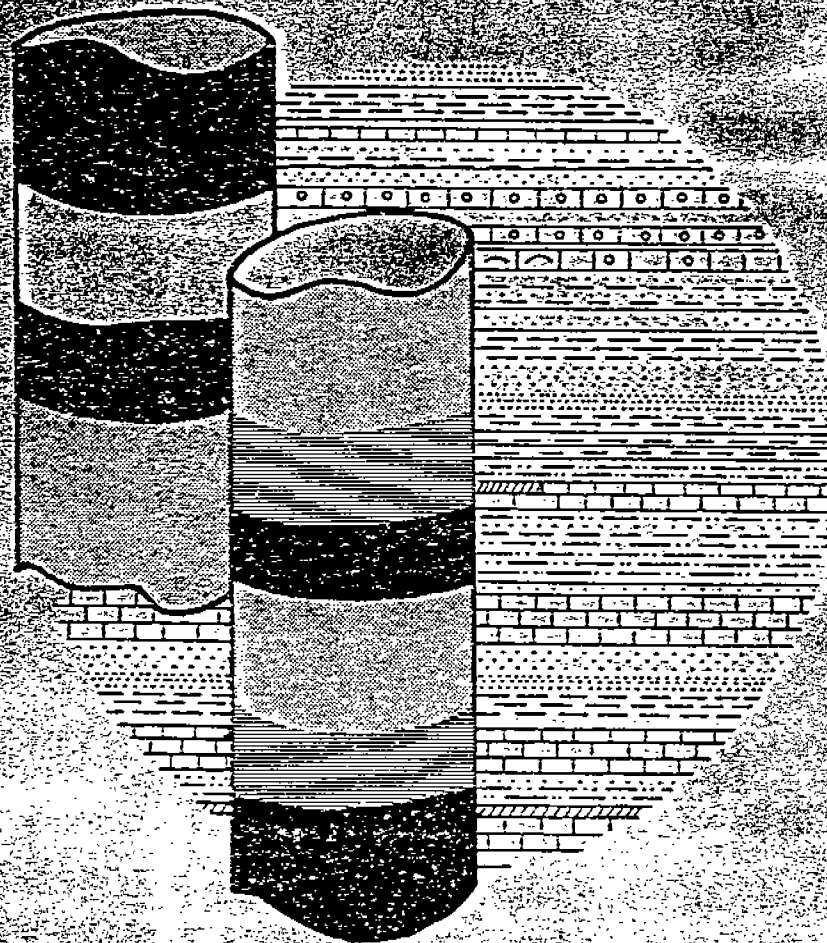

UNITED STATES DEPARTMENT OF THE INTERIOR
GEOLOGICAL SURVEY

GEOLOGIC AND OPERATIONAL SUMMARY,
COST NO. G-1 WELL, GEORGES BANK AREA,
NORTH ATLANTIC OCS

Roger V. Amato and John W. Bebout, Editors

Open-File Report 80-268

1980

This report has not been edited for conformity
with Geological Survey editorial standards
or stratigraphic nomenclature.

CONTENTS

	Page
Introduction.....	1
Operational data, by Michael A. Smith and Roger V. Amato.....	4
Drilling Programs.....	7
Samples and Tests.....	13
Weather.....	15
Lithology, by David J. Lachance.....	16
Shale analyses, by Lucille Tamm.....	22
Core descriptions and analyses, by David J. Lachance and Roger V. Amato.....	27
Biostratigraphy, by William E. Steinkraus.....	39
Age Determinations.....	41
Depositional environments, by David J. Lachance, John W. Bebout, and LeRon Bielak.....	53
Paleontologic Analyses.....	53
Lithologic Analyses.....	56
Geochemical Analyses.....	58
Seismic velocity and correlations, by Patrick S. Ditty.....	59
Interpretation of geophysical logs, by Stephen E. Prensky.....	68
Hole Condition.....	68
Log Analysis.....	69
Dipmeter Interpretation.....	75
Fluid analysis and pressure gradient, by Lucille Tamm.....	76
Geothermal gradient, by Dana S. Jackson.....	79
Geochemical analysis, by Michael A. Smith and Donnie R. Shaw.....	82
Source Rock Potential.....	82
Hydrocarbon Source Type.....	84
Thermal Maturity.....	87
Summary and Geochemical Significance.....	91
Petroleum potential, by Edvardas K. Simonis.....	96
Environmental considerations, by Frederick Adinolfi.....	100
Summary and conclusions.....	104
Selected references.....	107

ILLUSTRATIONS

(Plates in pocket)

	Page
Plate 1. Stratigraphic column and summary.	
2. Seismic Line 77-1.	
Figure 1. Index map of the North Atlantic OCS showing the location of the COST No. G-1 and G-2 wells on Georges Bank	2
2. Final location plat showing the position of the COST No. G-1 well	6
3. Graph showing the daily drilling progress	8
4. Schematic diagram showing casing and cement programs.	9
5. Changes with depth of drilling mud parameters10
6. Graph showing the changes in wet bulk density with depth.23
7. Core data summaries for conventional cores 2 and 3.28
8. Core data summary for conventional core 430
9. Core data summaries for conventional cores 5 and 6.31
10. Core porosity plotted against permeability for the COST No. G-1 well33
11. Core porosity plotted against depth34
12. Core permeability plotted against depth35
13. Summary and comparison of the biostratigraphic age interpretations42
14. Summary of paleoenvironmental interpretations54
15. USGS Multichannel Line 1 showing relationship of magnetic gravity and seismic data60
16. Location map showing COST No. G-1 well and its relation to seismic coverage61
17. Comparison of interval velocities COST No. G-1 well and from seismic line USGS 77-163

	Page
Figure 18. Time-depth curves constructed from COST No. G-1 well Uphole Survey and seismic line USGS 77-164
19. Composite plot showing change-in-interval velocity66
20. Graph showing geothermal gradient.80
21. Measurements of the organic richness of sediments.83
22. Measurements showing the type of organic matter.86
23. Schematic diagram showing oil and gas generation zones88
24. Measurements showing the maturity of organic matter.89

TABLES

Table 1. Mineral composition by weight percent from X-ray diffraction.24
2. Sidewall core analysis results36
3. Summary of the depths to the tops of the geologic systems, series, and/or stages represented in the COST No. G-1 well.40
4. Times of seismic events and their corresponding depths67
5. Summary of grain density and porosity values for cored intervals.72
6. Interval porosity average73
7. Summary of porosity and values74
8. Pressure data for depths 4,780 - 9,868 feet.77
9. Pressure data for depth 10,090 - 16,063 feet78
10. Comparison of offshore geothermal gradients.81
11. Hydrocarbon concentrations and other geochemical parameters93

EQUIVALENT MEASUREMENT UNITS

U. S. Customary to SI Metric Units:

1 inch = 2.54 centimeters
1 foot = 0.3048 meter
1 statute mile = 1.61 kilometers
1 nautical mile = 1.85 kilometers
1 pound = 0.45 kilogram
1 pound/gallon = 119.83 kilograms/cubic meter
1 pound/square inch = 0.07 kilograms/square centimeter
1 gallon = 3.78 liters (cubic decimeters)
1 barrel (42 US gals.) = 0.16 cubic meters

Temperature in degrees Fahrenheit = $^{\circ}\text{F}$ less 32, divided
by 1.8 for degrees Celsius.

Other Conversions: 1 knot = 1 nautical mile/hour
1 nautical mile = 1.15 statute miles or
6,080 feet

GEOLOGIC AND OPERATIONAL SUMMARY, COST NO. G-1 WELL,
GEORGES BANK AREA, NORTH ATLANTIC OCS

Roger V. Amato and John W. Bebout, Editors

INTRODUCTION

The first Continental Offshore Stratigraphic Test (COST) well on the U.S. North Atlantic Outer Continental Shelf (OCS) was drilled by Ocean Production Company between April 6 and July 26, 1976, and designated the COST No. G-1. Geological and engineering data obtained from this deep well in the Georges Bank Basin were used by the 31 participating companies and the U.S. Geological Survey (USGS) for evaluating the petroleum potential and possible drilling problems in the U.S. North Atlantic OCS area in preparation for Lease Sale 42 held on December 18, 1979.

Data from the well indicate that the best combination of reservoir rocks and sealing beds occurs between 5,200 and 9,940 feet. The organically richest rocks occur between 4,600 and 6,200 feet although they are thermally immature, while the deeper, thermally mature rocks are lean in organic matter. Thus, the rocks in the vicinity of the G-1 well are considered only marginally prospective for oil and gas. The stratigraphic test was drilled away from any potential petroleum-bearing feature, but in a block bordering several tracts that were ultimately included in the sale area.

The COST No. G-1 well was drilled to a depth of 16,071 feet at a location 89 statute miles east-southeast of Nantucket Island in 157 feet of water by a semi-submersible rig, the SEDCO J. A second deep stratigraphic test, the COST No. G-2 well, was located 42 statute miles east of the G-1 well and drilled to a measured depth of 21,874 feet in 1977 (fig. 1).

The public disclosure provision of the regulations on geological and geophysical explorations of the OCS (30 CFR 251.14) specifies that geological data from deep stratigraphic tests, including analyzed and interpreted information, shall be released 60 days after the issuance of the first Federal lease within 50 nautical miles of the test site, or 5 years after the well completion if no lease is issued. This requirement was also included as

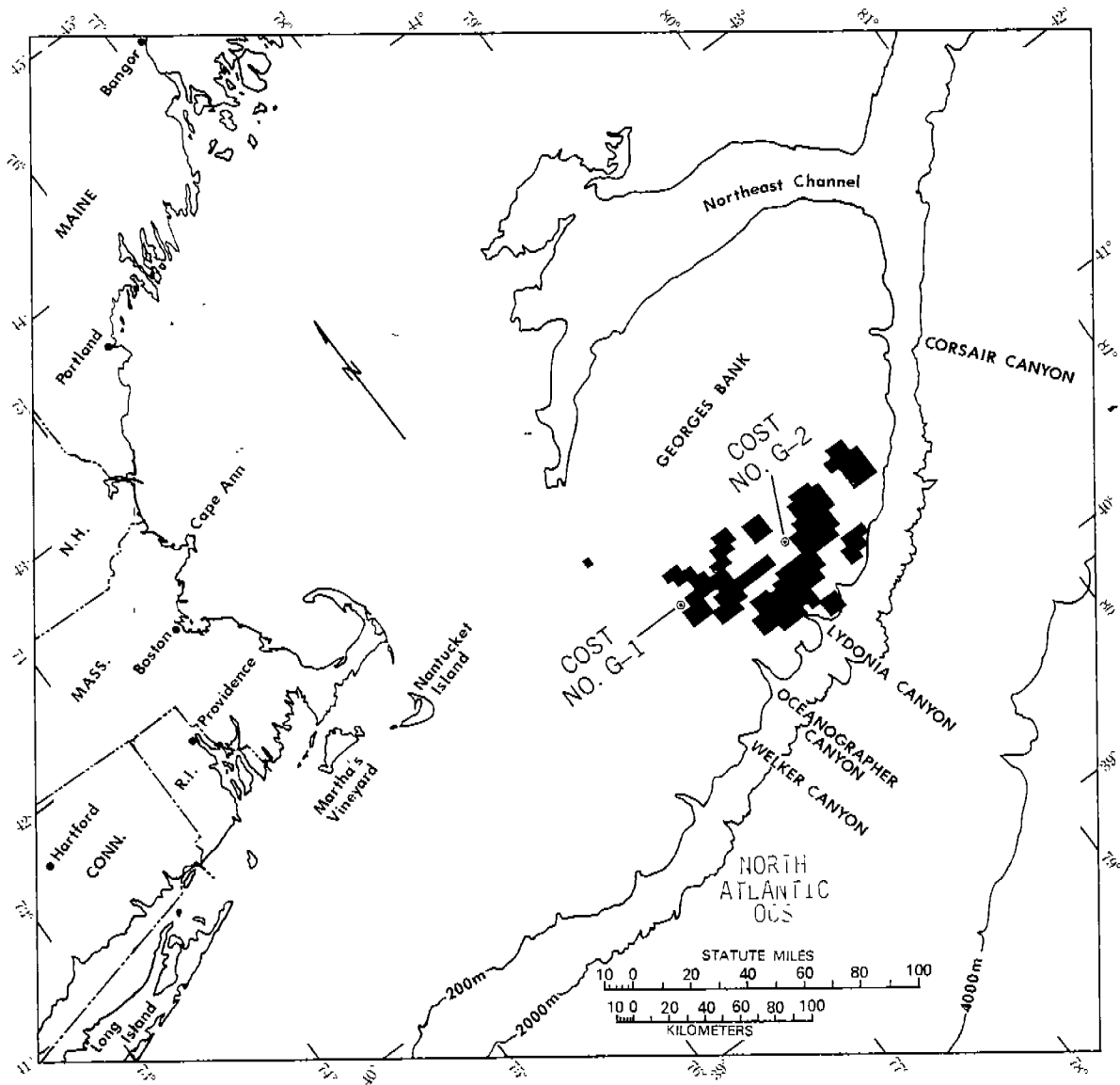

Figure 1. Index map of the North Atlantic OCS showing the location of the COST No. G-1 and G-2 wells on Georges Bank

Stipulation No. 4 in the list attached to OCS Permit No. E5-76 for the COST No. G-1 well operations. Block 123, immediately south of block 79 on which the G-1 was drilled, was leased on February 1, 1980 to Murphy Oil and Ocean Production Companies and block 124, adjoining the Southeast corner of block 79, was leased to Atlantic-Richfield and Murphy Oil Companies.

Information obtained on the well operations, lithology, potential source rock, porosity, temperature and pressure gradients, biostratigraphy and paleoenvironment is summarized in this report. Part of the information is based on USGS analyses and interpretations and part on contract reports by service companies, sample analyses by oil companies, and interpretations of electric logs, drill cuttings, and cores. All data may be inspected at the Public Information Office of the USGS, Conservation Division, Eastern Region, 1725 K Street, N.W., Washington, D.C. 20006. All depths referred to in this report are given in feet below the Kelly Bushing (KB) elevation which was 98 feet above mean sea level.

OPERATIONAL DATA

By Michael A. Smith and Roger V. Amato

The SEDCO J drill rig was released from the COST No. B-2 well site on the U.S. Mid-Atlantic shelf on March 28, 1976, and towed to Georges Bank for use in drilling the G-1 well. A towing time of 107 hours was required to traverse the 225 miles between well locations. The summary statement for the proposed deep stratigraphic test had been published jointly with notices for the Baltimore Canyon test well and no late participants joined the program. Ocean Production Company continued to act as the operator for the Atlantic COST group and the same 31 petroleum companies, listed below, shared expenses for the COST No. G-1 well:

- Amerada Hess Corporation
- Amoco Production Company
- Ashland Oil, Inc.
- Atlantic Richfield Company
- BP Alaska, Inc.
- Champlin Petroleum Company
- Chevron Oil Company
- Cities Service Oil Company
- Columbia Gas Development Corporation
- Continental Oil Company
- Diamond Shamrock Corporation
- ERA North America, Inc.
- Exxon Company, USA.
- Getty Oil Company
- Gulf Energy and Minerals Company, USA
- Kerr-McGee Corporation
- Marathon Oil Company
- Mobil Oil Corporation
- Ocean Production Company
- Pennzoil Company
- Phillips Petroleum Company

Placid Oil Company
Shell Oil Company
Skelly Oil Company
Sun Oil Company
Superior Oil Company
Tenneco Oil Company
Texaco, Inc.
Texas Eastern Transmission Corporation
Transco Exploration Company
Union Oil Company of California

Drilling stipulations required the operator to provide the USGS with all well logs, washed and unwashed samples, core slabs, and operational and technical reports including analyzed geological information at the same time as industry participants. The Maine Bureau of Geology, which received copies of the electric logs and proprietary reports, distributed information on the test well to the Geological Surveys of the other Atlantic coastal States involved.

The exact location of the COST No. G-1 well, 123.98 feet north-northeast of the proposed location, was lat $40^{\circ} 55' 52.108''$ N.; long $68^{\circ} 18' 18.917''$ W., or at Universal Transverse Mercator (UTM) coordinates (zone 19) X = 1,832,299.54 feet and Y = 14,865,743.51 feet. Figure 2 gives the final well site, 217.58 feet from the north line and 2,925.45 feet from the west line of Block 79 in OCS Protraction Diagram NK 19-11. The G-1 well was considered to be a vertical hole except for the bottom 571 feet. At a measured depth of 16,000 feet, the true vertical depth was determined to be 15,988.60 feet and the well location was 169.71 feet north and 252.44 feet west of the surface location.

The SEDCO J arrived on location on April 2, 1976, spudded the COST No. G-1 well on April 6, and finished drilling to a measured depth of 16,050 feet 102 days later on July 17th. After wireline logging, formation testing, and velocity and temperature surveys, the 21-foot interval to 16,071 feet was cored and a final series of sidewall cores was collected.

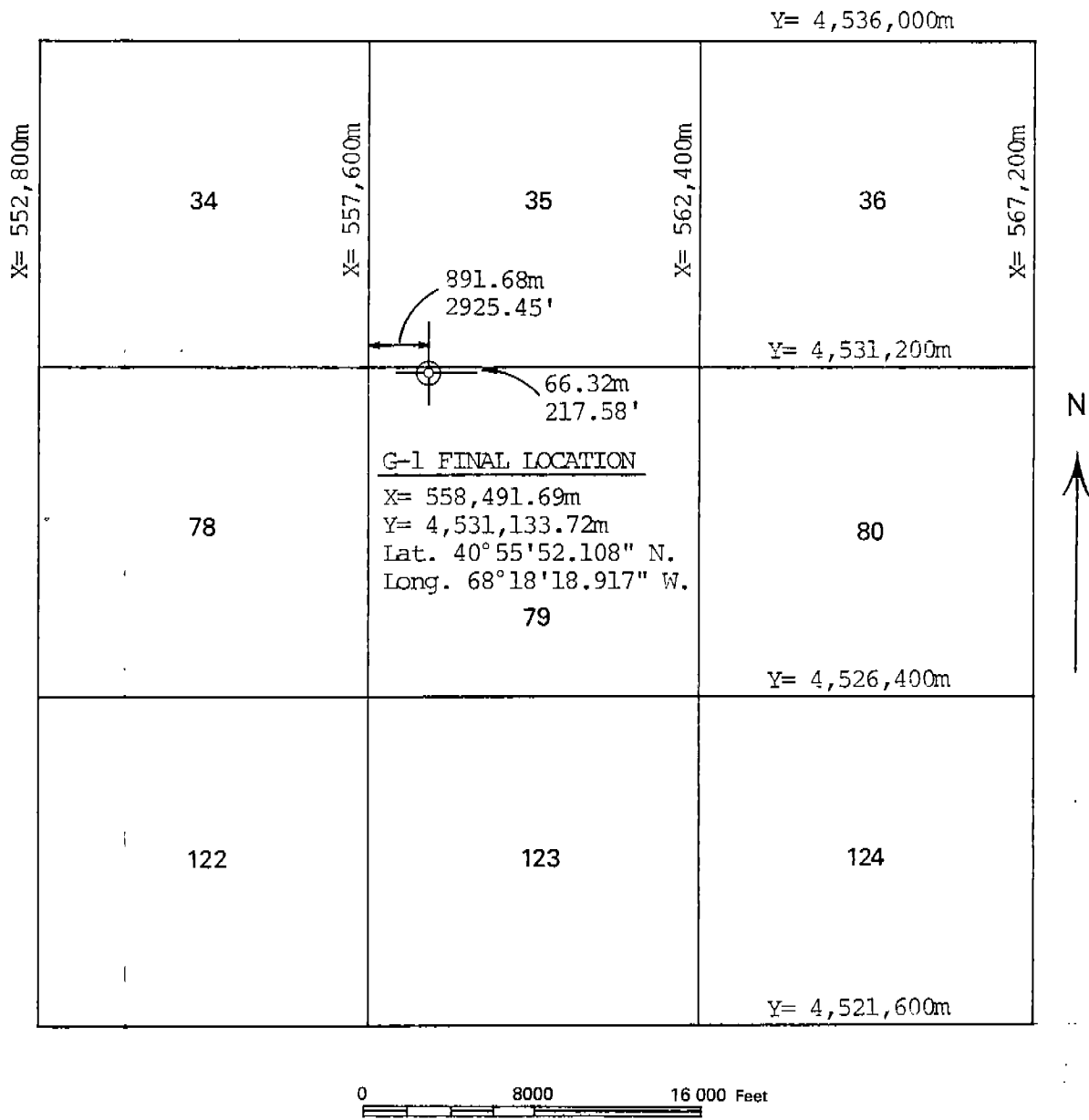

Figure 2. Final location plat showing the position of the COST No. G-1 well in OCS Protraction Diagram NK 19-11

The well was then plugged and abandoned in accordance with USGS North Atlantic OCS Order No. 3 and the drill rig was released on July 26, 1976.

Drilling Programs

The COST No. G-1 well was drilled using twenty 12 1/4-inch drill bits to a measured depth of 10,120 feet, and deepened with twenty-eight 8 1/2-inch bits to 16,050 feet. Additional bits were used to open the hole before setting the larger casing strings, to drill through cement, for cleanout trips, and for the conventional coring program. Depths where the 12 1/4- and 8 1/2-inch bits were changed are marked on figure 3, a graph showing the daily drilling progress for the well. Hourly drilling rates ranged from 2 to 110 feet and averaged 82 feet to 4,060 feet, 20 feet in the next interval to 10,120 feet, and 7 feet for the remainder of the well.

Four casing strings were cemented in place in the COST G-1 well to a total depth of 10,090 feet. One hundred and sixty nine feet of 30-inch casing was set to a depth of 424 feet (KB) in a hole widened to 36 inches to a depth of 475 feet. Seven Hundred and seventeen feet of 20-inch casing was cemented in a 26-inch hole to a depth of 972 feet. The 13 3/8-inch casing consisted of 3,767 feet of pipe set to a depth of 4,022 feet in a 17 1/2-inch hole. The final string consisted of 9,835 feet of 9 5/8-inch casing set in a 12 1/4-inch hole to a depth of 10,090 feet. Class B cement was used for all but the final casing string. Five hundred 90-pound sacks were required to cement the 30-inch string. Nine hundred sacks for the 20-inch string and 1,800 sacks for the 13 3/8-inch string. The 9 5/8-inch casing string needed 1,310 sacks of class H cement.

Drilling mud for the G-1 well consisted of high-gel spud mud to 4,060 feet and lignosulfonate mud for the remainder of the hole (fig. 5). Mud weight was kept at about 9.0 pounds per gallon to 5,000 feet, although it was temporarily increased to 9.8 during setting of 13 3/8-inch surface casing, then increased gradually to 10.4 at total depth. Viscosity ranged from 35 to 52 seconds, except above 1,026 feet and during setting of the

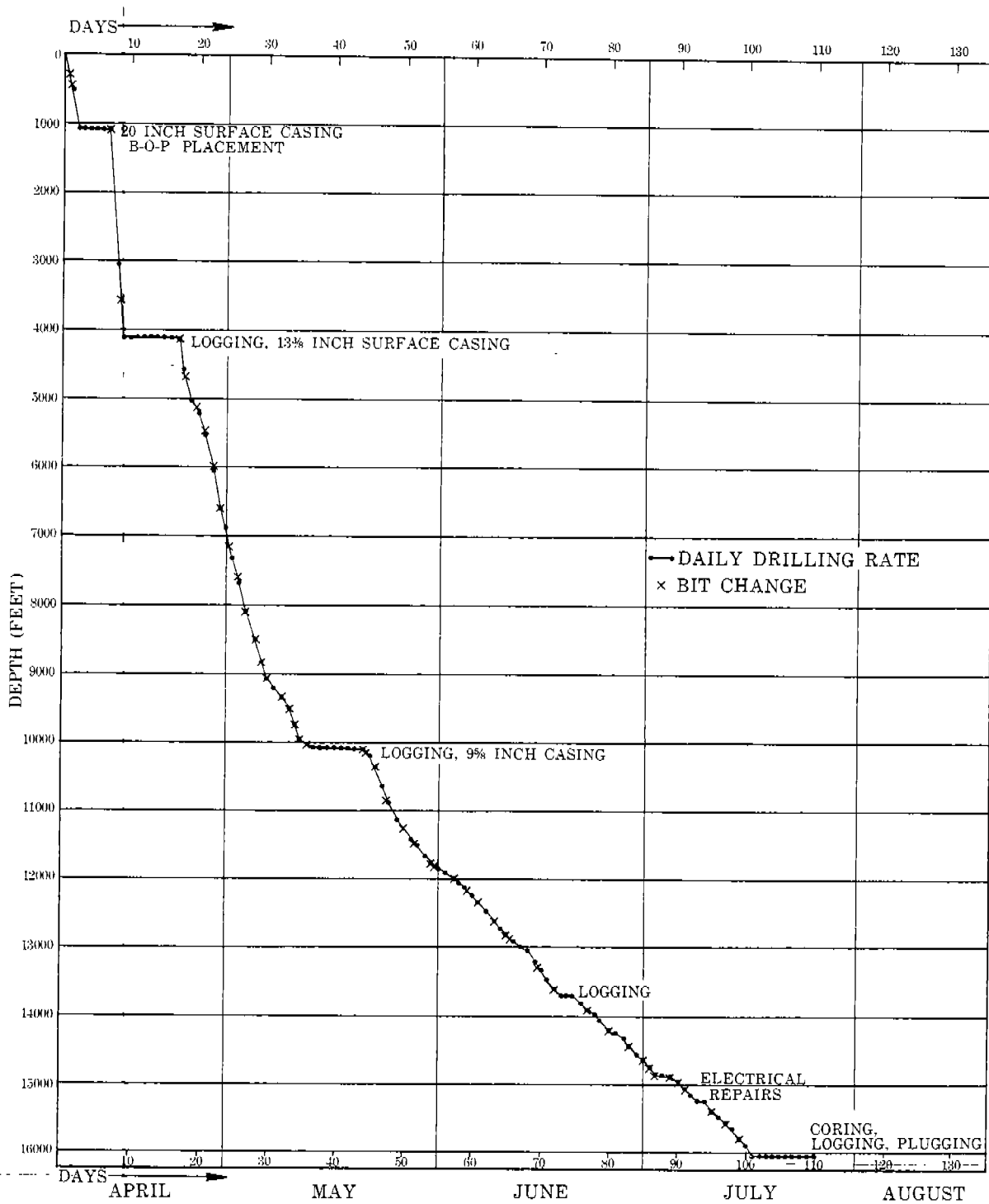

Figure 3. Graph showing the daily drilling progress for the COST No. G-1 well

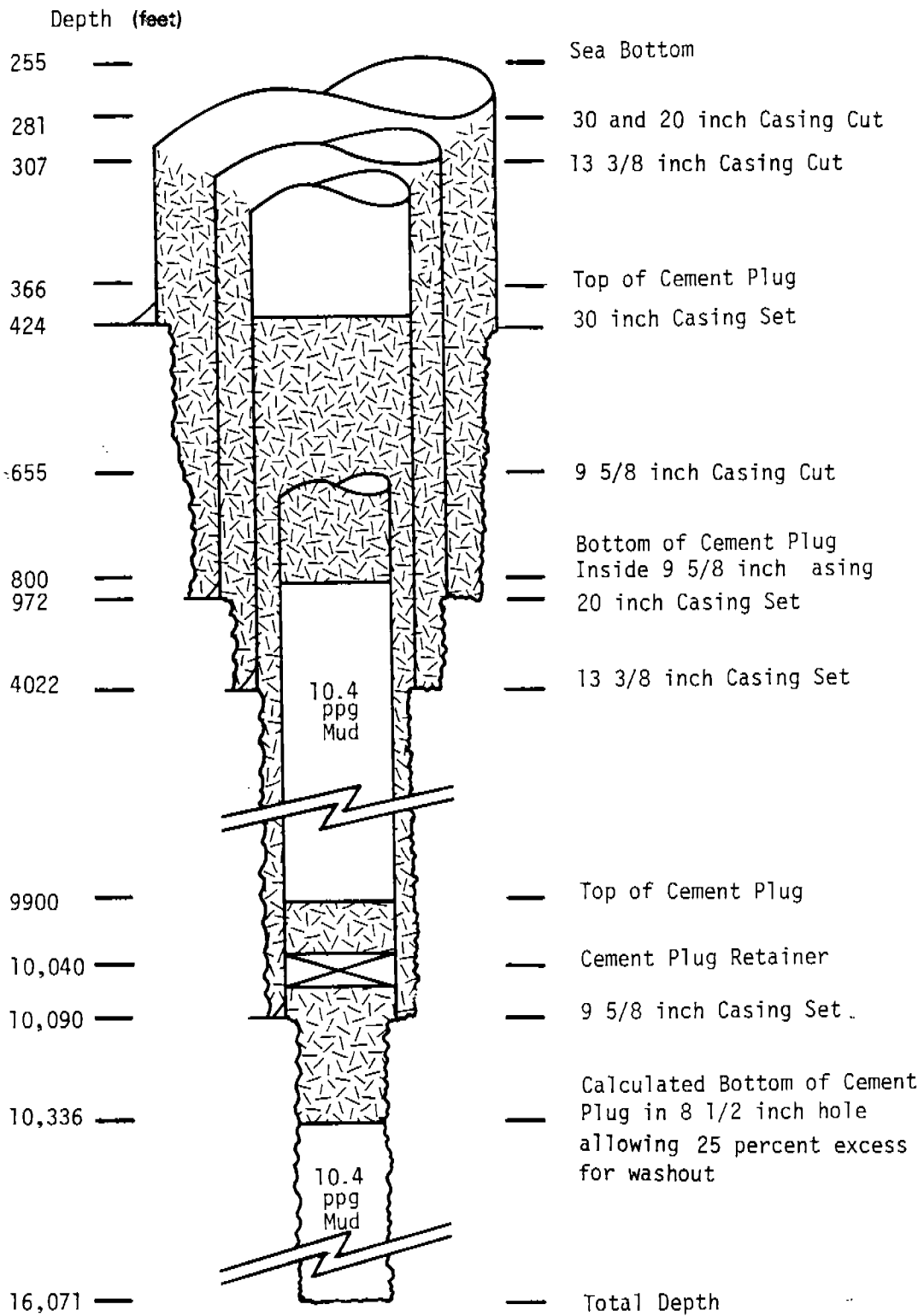
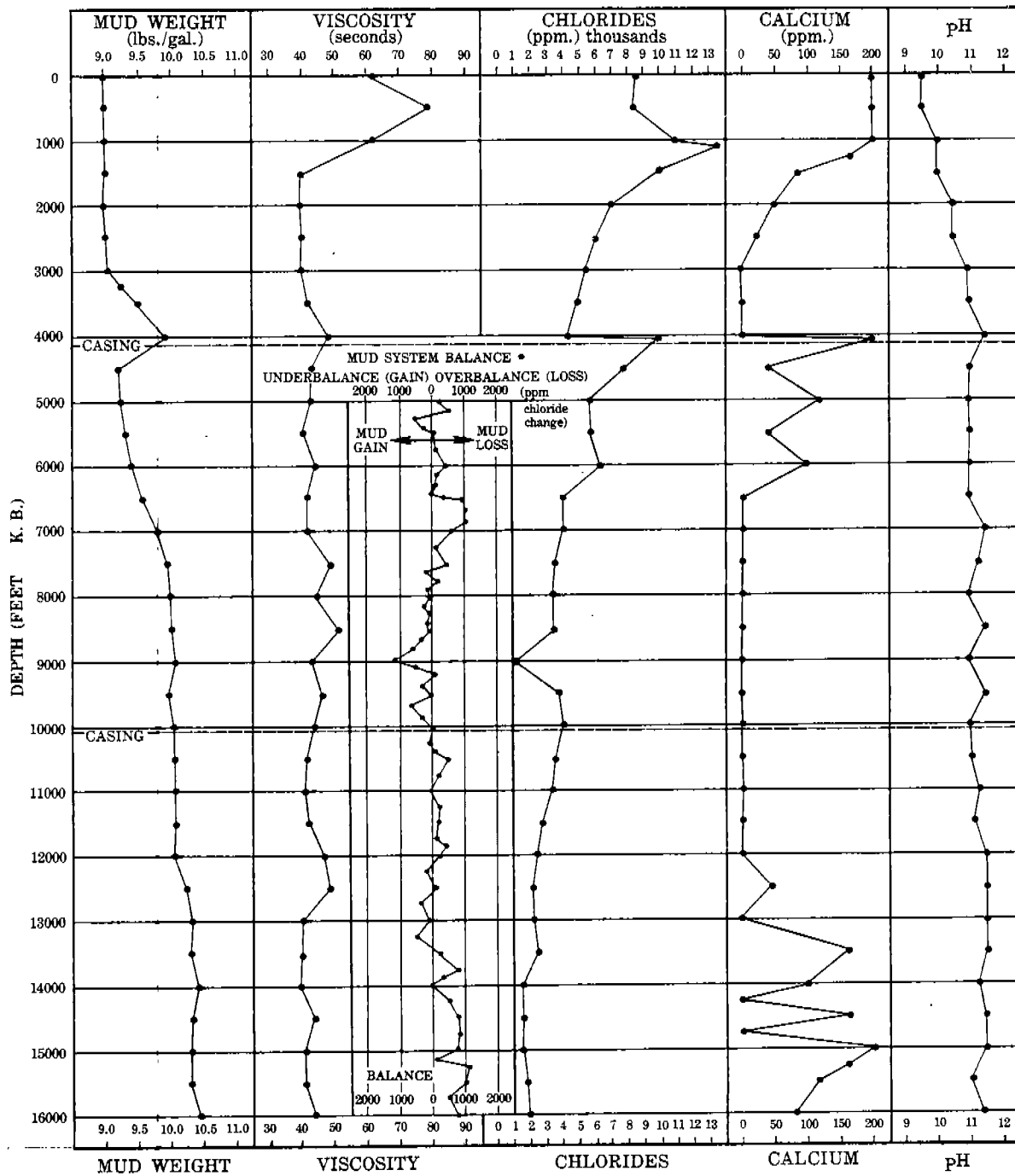

Figure 4. Schematic diagram showing casing and cement programs, COST No. G-1 well



*NO MEASUREMENTS WERE MADE ABOVE 5000 FEET

Figure 5. Changes with depth of drilling mud parameters, including mud weight, viscosity, mud system balance, total chlorides, total calcium and pH

surface casing. Chloride values were as high as 13,600 ppm in the shallow part of the hole and decreased to 1,800 ppm at total depth. The calcium concentration varied considerably with values up to 200 ppm, although it was generally limited to concentrations near zero. The large variation in amounts of calcium, especially from 13,000 feet to total depth, is probably the result of drilling through thick beds of anhydrite (CaSO_4). The pH ranged from 9 to 11.57 offering some protection against the danger of encountering H_2S gas while drilling.

Several logs were run by the Analysts, Inc., simultaneously with the drilling of the COST No. G-1 well. These logs monitored the mud system and were run primarily to ensure more efficient drilling. The overall mud system balance was checked by the Delta Chloride Log (DCL) which continuously recorded the difference between suction pit chloride and flow line chloride concentrations. When suction pit readings were higher than flow line readings, an overbalanced mud system with possible mud loss into the exposed formations in the hole occurred. The opposite situation resulted in an underbalanced mud system whereby formation water flowed into the hole and diluted the mud. A balanced mud system was generally maintained in the G-1 well as indicated (fig. 5) with a slightly overbalanced system occurring from 6,400 to 6,900 feet and from 13,700 feet to total depth. A second drilling system log, the Physical Formation Log (PFL), displayed the rate of drill bit penetration, rock type, shale density, mud temperature, mud weight, mud viscosity, and gas detection with chromatographic analysis. No anomalous gas values were detected. The Instantaneous Drilling Evaluation Log (IDEL), while not intended for final well evaluation, gave an immediate estimate of porosity and pore pressure.

The cumulative cost for the G-1 well was \$8.30 million. This amount included \$378 thousand for demobilization of the SEDCO J, \$212 thousand for preliminary site surveys, \$159 thousand for mud costs, and about \$360 thousand for the casing program costs. The time spent on various activities in the drilling operation was as follows:

	<u>Hours</u>	<u>Percent of Total</u>
Drilling	1,244.5	45.4
Tripping	507.5	18.5
Wire line logging	204.0	7.4
Circulating & conditioning mud.	143.0	5.2
Rigging up, running, & testing casing.	108.5	4.0
Reaming	85.5	3.1
Testing BOP stack	75.5	2.8
Conventional coring	72.0	2.6
Running & pulling BOP stack & riser	52.5	1.9
Rig repair.	44.5	1.6
Waiting on weather.	40.0	1.5
Deviation survey.	21.0	0.8
Cementing	19.0	0.7
Cutting off drill line.	11.5	0.4
Other	<u>113.0</u>	<u>4.1</u>
TOTAL:	2,742.0	100.0

Samples and Tests

Five conventional diamond cores were taken in the COST No. G-1 well after the first unsuccessful coring attempt at 5,120 to 5,142 feet. Core 2 recovered 12 feet between 5,469 and 5,489 feet, core 3 recovered 23 feet at 9,980 to 10,006 feet, core 4 recovered 44.7 feet between 12,897 and 12,947 feet, core 5 recovered 11.6 feet at 13,929 to 13,944 feet and core 6 recovered 12 feet from 16,051 to 16,071 feet.

One-inch diameter plugs were drilled in each foot of sandstone core; these were leached of salt and dried. Air permeabilities, Boyle's Law porosities, and grain densities were determined for 7 plugs from core 2, 13 plugs from core 3, and 4 plugs from core 5. A grain-size analysis was performed on 7 unconsolidated samples from core 2. Petrographic analysis of 78 thin sections and mineral content determination by X-ray diffraction for 24 samples from the 5 cores were also made. The biostratigraphic study of the G-1 well used 32 samples taken from all of the conventional cores. Thermal conductivity measurements, generally parallel to bedding, were made on 29 one-inch diameter plugs from all cores and K-Ar age determinations were obtained for 3 samples from core 6.

Three series of percussion sidewall cores were collected providing a total of 687 samples. In the first series, 196 cores were recovered from 211 attempts between 993 and 4,052 feet. From 4,101 to 10,074 feet, 348 cores were collected in 471 attempts, and between 10,134 and 16,028 feet, 143 cores were taken in 330 attempts. Detailed analysis of 117 sandstone cores from all levels in the well determined the values of important rock properties. Porosities were measured by the Summation-of-Fluids method and permeabilities were determined empirically. Residual fluid saturations were measured using an electric retort method and grain densities were also calculated from the analytical data. Thin sections from 112 samples were described and 39 finely ground samples were analyzed for mineral content by X-ray diffraction. In addition, 320 sidewall core samples were processed for use in the biostratigraphic study.

Well cuttings samples collected from 252 60-foot intervals were analyzed in the detailed organic geochemistry program. Additional geochemical studies made on the cuttings included vitrinite reflectance analysis of 46 samples, light hydrocarbon analysis to infer paleotemperatures for 23 samples, elemental analysis of kerogen separated from 48 samples, and carbon isotopic compositional data for 38 samples. The initial biostratigraphic analysis was based on information obtained from 500 cuttings samples. The mineral composition based on X-ray diffraction analysis, wet bulk density, grain density, and porosity of 63 shale drill cuttings was also determined.

Logging runs were made at measured well depths of 4,060, 10,120, 13,644 and 16,050 feet in the G-1 well with an upper limit of 971 feet for most logs. The Dual Induction-Laterolog, Proximity Log Microlog, and Sonic Log with 7- to 9-foot spacing were recorded on all runs at scales of both 2 and 5 inches to 100 feet. A 2- and 5-inch Sonic Log with 5- to 7-foot spacing was obtained from Run No. 1, and a 2- and 5-inch Borehole Compensated Sonic Log was run for the remainder of the hole below 4,060 feet. An experimental 5-inch Sonic Log with 9-foot spacing was also run between 9,900 and 16,000 feet. Detailed logs at the 5-inch scale were run for the full interval with the Compensated Formation Density Log, the Simultaneous Compensated Neutron-Formation Density Log, and the Four-Arm, High-Resolution Continuous Dipmeter. A Computed Dipmeter with a graphical presentation (arrow plot) was printed at a scale of 1 and 5 inches to 100 feet for the entire well. The Temperature Log was run at the 2-inch scale at all well depths below the mudline. A 1-inch Continuous Velocity Log was computed from data off the Sonic Logs and the Well Seismic Tool.

Twenty Repeat Formation Tests were made in the upper part of the hole after completion of the logging operation at a measured depth of 10,120 feet and 9 additional tests were attempted for the remainder of the well after the final logging run. Pressure data were obtained at

the test depths, but no formation water was recovered. Samples of drilling fluid filtrate were collected in four of the upper tests, and drilling mud was recovered in two deeper tests. No conventional drill stem tests were attempted in the COST No. G-1 well.

Weather

Before the G-1 well operation provided information for the spring and early summer months, available weather data for Georges Bank consisted generally of shipboard observations and information collected during environmental studies. Weather observations were recorded every 3 hours with wind speeds averaged over a 15-minute interval and wave data averaged over a 3-minute interval. Wind speed was measured by an anemometer on top of the drilling derrick at a height of about 250 feet above sea level. Average monthly values, taken during drilling, were as follows:

	<u>April</u>	<u>May</u>	<u>June</u>	<u>July</u>
Wind speed (knots) and direction	19NW	19SW	22SW	18SW
Waves (feet)	5	3	2	1
Swells (feet)	4	4	5	4
Air temperature (°F)	46	52	57	62
Sea temperature (°F)	37	48	54	58
Barometric pressure (millibars)	1012	1015	1018	1015

Moderate weather conditions were expected during the drilling program because the most severe weather in Georges Bank generally occurs during the winter months. Weather delays totaled 40 hours, or nearly 1.5 percent of the time on location, but mainly involved waiting for calmer seas in order to rerun and to tension the anchors.

LITHOLOGY

By David J. Lachance

Drill cuttings samples from the COST No. G-1 well were obtained at 30-foot intervals from 1,030 to 4,060 feet, 110-foot intervals from 4,060 to 12,630 feet, 5-foot intervals from 12,630 to 12,900 feet, and 10-foot intervals from 12,900 to 16,050 feet. A lithologic log was prepared for the G-1 participants by Ocean Production Company, and is available for inspection along with other logs, samples, and cores at the Public Information Office of the USGS, 1725 K Street, N.W., Suite 204, Washington, D.C. 20006.

The following summary of the strata penetrated by the COST No. G-1 well is based on my own detailed lithologic studies of the drill cuttings. The lithologic column is summarized on plate 1.

Section IA, (1,030-3,745 feet)

This section consists of calcareous shaly, quartz sands and light- to medium-gray gumbos and shales, characterized by glauconite pellets mixed with the sand grains. The sands consist of coarse to very coarse, locally pebbly, angular to subangular, moderately sorted, quartz grains which are usually clear, milky, or yellow, and contain minor amounts of glauconite. Sparse constituents are shell fragments, gastropods, foraminifers, zircon, muscovite, biotite, chlorite, pyrite, lignite, feldspar, and calcite. The gumbo and shale are dominantly light- to medium-gray.

Section IB (3,745-4,980 feet)

This section consists of alternating units of sandstone and shale. The section is characterized by both plant material in the shale, and the absence of glauconite and fossils in the sandstone. The sandstone is slightly shaly, and consists of pebbly, coarse to very coarse, angular, poorly sorted quartz grains which are usually clear, white, or smoky in color. Trace constituents in the sandstone include coal, pyrite, and muscovite. The shale is dominantly light- to medium gray and contains traces of plant material, along with a few laminae of reddish-brown shale.

Section IC, (4,980-6,250 feet)

This section consists of thin, alternating sandstone and shale, and is characterized by thin beds of buff, silty dolomite throughout the section. The sandstone consists of locally pebbly, fine to very coarse, angular, poorly sorted quartz grains which are usually white to light-gray in color and commonly have a calcareous cement. Sparse constituents include shell fragments, muscovite, biotite, anhydrite, pyrite, calcite, chlorite, and feldspar. The shale is slightly calcareous, light- to medium-gray, and contains traces of pyrite, coal, and plant material. The dolomite occurs as scattered, thin beds. It is buff colored, slightly silty, and cryptocrystalline.

Section IIA (6,250-7,490 feet)

This section consists of a sequence of alternating shaly sandstone and gray and reddish-brown shale. The section is characterized by the first downhole appearance of moderate amounts of mixed red and gray shale and the presence of thin beds of buff limestone and dolomite, along with traces of green, probably chloritic, shale in the upper part of the section. The sandstone is very shaly, calcareous, and is composed of locally pebbly, very fine to very coarse, angular to subangular, moderately sorted quartz grains, which are usually clear to light-gray. Trace constituents are pyrite, muscovite, coal, and shell fragments, with locally abundant coal.

The shale is dominantly light- to medium gray and reddish brown and contains traces of coal, pyrite and plant material. The thin beds of limestone and dolomite are characteristically microcrystalline and buff to brown although traces of light-gray dolomite are also present. Trace constituents are pyrite, glauconite, and fossils.

Section IIB (7,490 to 9,940 feet)

In gross lithology this section resembles Section IIA, but may be distinguished from that section by traces of very thin, white to light gray limestone as well as buff limestone and dolomite, a slight increase

in the amount of glauconite, and the absence of green shale. The sandstone is very shaly, and is dominantly composed of locally pebbly, very fine to very coarse, angular to subangular, poorly to moderately sorted, clear to light gray quartz grains, with a white to light gray carbonate cement that becomes locally iron-stained toward the base of the section. Trace constituents include pyrite, coal, mica and glauconite. The shale is light- to medium-gray and reddish brown in color. Trace constituents, predominantly in the gray shales, include shell fragments, chlorite, coal, pyrite, and calcite spar. The carbonates include white to light-gray, fine to cryptocrystalline limestone, and buff to brown, fine to microcrystalline limestone and dolomite, with traces of pyrite.

Section IIIA, (9,940 to 10,060 feet)

This section consists of peloidal carbonates, shale, and calcareous sandstone. It is characterized by the first downhole appearance of peloidal carbonates. The sandstone consists of locally pebbly, very fine to fine, angular, moderately sorted, quartz grains with trace amounts of pyrite, oolites, and pellets. The shales are dominantly red and light- to medium-gray; traces of lignite occur in the gray shales. The carbonates consist of light- to medium gray, locally sandy, fine to cryptocrystalline, peloidal, fossiliferous limestone.

Section IIIB (10,060-10,470 feet)

This section consists of shales with minor amounts of peloidal carbonates, siltstone, and sandstone. The siltstone and sandstone are present in only minor amounts, and comprise calcareous silt, and very fine to fine, angular, poorly sorted, quartz sandstone with light-gray, buff, and reddish-brown cement. Traces of pyrite and quartz pebbles are present. The shale is dominantly light- to medium-gray, with minor to trace amounts of reddish-brown and green shale. Traces of coal occur in the gray shale. The carbonates consist of light- to medium-gray, and buff, fossiliferous, fine to cryptocrystalline, slightly silty, peloidal limestones with traces of gypsum.

Section IIIC (10,470-11,900 feet)

Section IIIC has been divided into three subsections and is characterized by peloidal carbonates and red and gray shale.

Subsection III C-1 (10,470-11,020) consists of shale and carbonate and in lesser amounts, calcareous sand and siltstone. The sand and siltstone are very fine- to fine-grained, angular, poorly to moderately sorted, and contain traces of pyrite and sparse amounts of coal, pellets, shell fragments, and and glauconite. The shale is dominantly light- to medium-gray, with traces of coal, and minor amounts of green shale. The carbonates consist of slightly peloidal, silty, light- to medium-gray, fine to cryptocrystalline limestone with traces of pyrite, and minor amounts of oolites, and pellets; limestone becomes dolomitic at the base of the subsection.

Subsection III C-2 (11,020-11,460) consists of shale and sparse sandstone and siltstone similar to those in subsection III C-1, as well as carbonates. The shales are light- to medium-gray, reddish-brown, and locally green. The carbonates are similar to those in subsection IIIC-1, although the carbonates in the lower half of the subsection are light- to medium-gray as well as buff.

Subsection III C-3 (11,460-11,900) is similar to subsection IIIC-1, and is only distinguished from it by the presence of buff, fine to cryptocrystalline limestone and the paucity of pyrite in the sandstones and siltstones.

Section IV, (11,900-12,360 feet)

This section consists of shale, carbonates, minor amounts of sandstone, siltstone, and scattered laminae of anhydrite. The sandstone is light-gray to pink and red, in fine- to medium-grained, angular, with a calcareous cement, and sparse amounts of pyrite, and coal laminae. The siltstone is identical to the sandstone in all characteristics except grain size. The shale is light- to dark-gray and reddish-brown, with traces of anhydrite, coal, and pyrite. The carbonates consist of light- to medium-gray, fine to cryptocrystalline, slightly fossiliferous limestone

and dolomite, with traces of pyrite. Minor amounts of buff, fine to cryptocrystalline dolomite occur in the uppermost part of the section.

Section V A, (12,360-13,320 feet)

Dolomite, anhydrite, thin shale beds, and minor amounts of slightly micaceous sandstone comprise this unit. The dolomite is fine to cryptocrystalline, light- to dark-gray and buff, and contains traces of calcite, pyrite, and pellets. The anhydrite is white- to light-gray and pink and exhibits both massive and chicken wire structure. The shale is typically medium- to dark-gray and reddish-brown. The sandstone consists of light-gray to pink and red, very fine- to medium- and locally coarse-grained angular, moderately-sorted, quartz grains cemented with a noncalcareous (clay) cement.

Section V B (13,320-13,610 feet)

This section consists of interbedded and interlaminated dolomite, sandstone, shale, and anhydrite. The sandstone consists of light-gray to pink and red, very fine- to coarse-grained, angular, poorly- to moderately-sorted, quartz grains with a slightly dolomitic cement, and traces of muscovite, pyrite, coal laminae, and glauconite. The shale is medium- to dark-gray, and reddish-brown. The anhydrite occurs as thin laminae in the shale; it is white to light-gray and pink, and exhibits both massive and chicken-wire structure. The dolomite is light- to dark-gray and buff, fine to cryptocrystalline, slightly sandy, pelletal, and argillaceous.

Section VI A, (13,610-14,130 feet)

This section is characterized by an assemblage of dolomite, sandstone, and shale with traces of anhydrite. The dolomites are light- to medium-gray and buff, fine to cryptocrystalline, slightly argillaceous, and slightly sandy, with traces of pyrite. The shale is reddish-brown and medium- to dark-gray, slightly micaceous, and contain traces of anhydrite. The sandstone is fine- to coarse-grained, locally pebbly, light-gray, pink and red, poorly- to moderately-sorted, angular, and contains traces of glauconite, muscovite, and coal.

Section VI B, (14,130-14,910 feet)

Lithologically this section resembles section VI A; only minor amounts of dolomite are present, however and the sandstone is locally conglomeratic and contains traces of magnetite.

Section VI C, (14,910-15,600 feet)

This section is composed of sandstone, conglomerate, minor amounts of shale and carbonates. The sandstone and conglomerate grade into one another and are fine- to coarse-grained, angular, poorly- to moderately-sorted, and light-gray to pink and red with few trace constituents other than metamorphic rock fragments, reworked sedimentary clasts, and coal. The conglomerate is essentially equivalent in composition to the sandstones. The shale is reddish-brown and medium- to dark-gray with traces of chicken-wire anhydrite. The carbonates consist of light- to medium-gray and buff, fine to cryptocrystalline, slightly argillaceous dolomite and light- to medium-gray, fine to cryptocrystalline, pelletal, slightly fossiliferous limestone.

Section VII, (15,600-16,071 feet)

This section consists of sericitic metadolomite, metaquartzite, and graphitic phyllite, and is believed to be basement.

SHALE ANALYSES
By Lucille Tamm

Amoco Production Company (written communication, 1976) obtained mineralogy, density, and porosity data for 63 samples of shale drill cuttings collected between 4,960 feet and the bottom of the COST No. G-1 well. Shale cuttings were taken from 10-foot intervals, generally 150 feet apart.

X-ray diffraction analysis of crushed samples was used to calculate mineral percentages in the shale. The clay mineralogy was determined for oriented samples on glass slides. The clay percentages of individual minerals in the clay fraction are shown in Table 1. It was determined that quartz is the predominant mineral in almost all samples below 5,070 feet. The clay content of all the samples analyzed varies between 11 and 63 percent of the total material in a particular sample.

Kaolinite is the predominant clay mineral to a depth of about 6,400 feet. In the samples taken from 6,460, 6,910, and 7,210 feet, the amount of kaolinite is approximately equal to the amount of illite present. Below 7,210 feet the kaolinite content steadily decreases until only trace amounts are found in the samples below 10,500 feet, and the illite content shows a corresponding increase in these samples. Throughout the section, chlorite occurs in varying amounts as the third major clay mineral forming up to 45 percent of the clay fraction in individual samples. Traces of expandable mixed-layer (illite-montmorillonite) were detected below 7,500 feet.

Grain density measurements were made on dried, picked shale cuttings. The wet bulk density for fresh water-saturated shale and the shale porosity were determined by a liquid pycnometric technique using a nonpolar organic solvent (fig. 6). The wet bulk density increases rapidly from 1.9295 at 4,960 feet to 2.3887 at 5,560 feet as the percentage of clay minerals in the total sample drops from 63 to 39 percent. The density then increases gradually to 2.5772 at 8,710 feet. For the remainder of the well, the density varies between 2.4311 and 3.0014 but most samples have densities between 2.55 and 2.60.

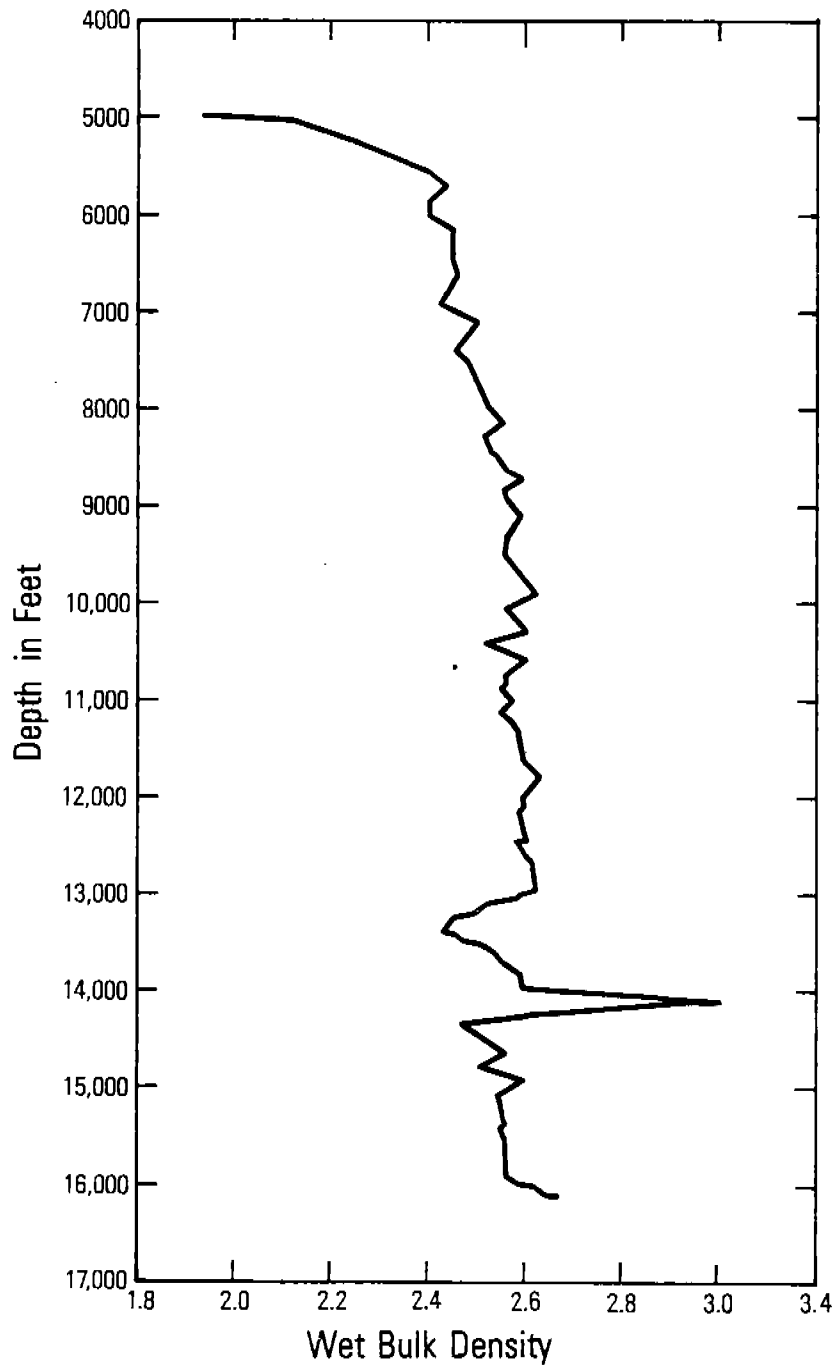

Figure 6. Graph showing the changes in wet bulk density with depth in the COST No. G-1 well

Table 1.-- Mineral composition by weight percent from X-ray diffraction, COST No. G-1 Well.

DEPTH(Feet)	Quartz	Feldspar	Calcite	Dolomite	Siderite	Anhydrite	Pyrite	Kalolinite	Illite	Chlorite	Mixed-Layered Illite/Montmorillonite	% Expandable	% Clays
4,960-70	35	2	-	-	-	-	-	48	15	-	-	-	63
5,060-70	35	T*	-	-	3	-	10	40	12	-	-	-	52
5,260-70	50	2	-	-	2	-	-	30	12	4	-	-	46
5,560-70	50	2	3	-	3	-	3	25	10	4	-	-	39
5,710-20	53	2	3	-	-	-	2	25	10	5	-	-	40
5,860-70	58	2	2	-	T	T	2	22	9	5	-	-	36
6,010-20	60	2	5	-	-	T	-	17	8	8	-	-	33
6,160-70	66	2	-	-	2	-	-	15	7	8	-	-	30
6,460-70	66	2	-	-	T	T	T	12	12	8	-	-	32
6,610-20	78	2	-	-	T	T	T	9	6	5	-	-	20
6,910-20	80	2	-	-	T	T	T	7	7	4	-	-	18
7,050-60	75	2	-	-	-	T	T	8	10	3	-	-	21
7,210-20	67	2	2	-	-	T	T	10	12	5	-	-	29
7,360-70	67	4	-	-	-	T	-	9	12	5	-	-	27
7,510-20	79	2	-	-	-	T	-	7	8	4	T	?	19
7,660-70	76	4	-	-	-	T	-	6	10	4	T	?	20
7,810-20	76	2	-	-	-	T	T	8	10	4	T	?	22
7,960-70	71	2	2	-	-	T	2	8	12	3	T	?	23
8,110-20	79	2	-	-	-	T	2	6	8	3	T	?	17
8,260-70	71	3	T	-	-	T	2	9	12	3	T	?	24
8,560-70	66	2	2	-	2	T	2	10	12	4	T	?	26
8,710-20	76	2	-	-	T	T	2	10	8	2	T	?	20
8,860-70	76	2	-	-	-	-	2	8	10	2	T	?	20
9,010-20	71	4	T	1	T	T	2	8	11	4	T	?	23
9,160-70	68	2	-	-	2	T	2	8	11	7	T	?	26
9,460-70	81	2	4	-	-	-	2	4	5	2	T	?	11
9,610-20	78	2	-	-	-	T	2	4	12	2	T	?	18
9,760-70	76	2	3	2	-	T	2	3	6	3	T	?	12

* T = Trace (1%)

Table 1.--Mineral composition by weight percent X-ray diffraction, COST No. G-1 well -- continued

Depth(Feet)	Quartz	Feldspar	Calcite	Dolomite	Siderite	Anhydrite	Pyrite	Kaolinite	Illite	Chlorite	Mixed-Layered Illite/Montmorillonite	% Expandable	% Clays
9,910-20	80	2	2	-	-	F	2	3	8	3	F	?	14
10,060-70	79	2	4	-	-	F	2	3	8	2	F	?	13
10,210-20	73	3	3	-	-	-	2	4	9	6	F	?	19
10,360-70	78	3	4	F	-	-	-	3	7	5	F	?	15
10,510-20	80	4	5	-	-	F	-	-	6	5	-	-	11
10,660-70	69	4	3	3	-	F	2	-	14	5	F	?	19
10,810-20	73	4	2	3	-	-	1	-	12	5	F	?	17
10,960-70	69	4	4	3	F	2	F	-	12	6	F	?	18
11,110-20	69	4	2	3	2	2	2	1	10	5	-	-	17
11,260-70	64	4	2	4	-	1	2	-	16	7	F	?	23
11,410-20	65	4	3	6	3	2	2	1	8	6	-	-	15
11,560-70	64	4	3	4	2	3	2	F	12	6	-	-	18
11,710-20	69	4	3	3	-	F	1	-	15	5	-	-	20
11,860-70	55	6	2	-	-	2	2	-	25	7	F	?	32
12,010-20	52	5	-	2	-	2	3	-	30	6	F	?	36
12,160-70	56	5	-	2	-	7	-	-	25	5	F	?	30
12,310-20	52	20	2	3	-	3	-	-	15	5	F	?	20
12,460-70	31	7	-	31	-	5	2	-	17	7	F	?	24
12,610-20	41	3	-	6	-	2	2	-	40	6	F	?	46
12,910-20	28	4	-	2	-	6	2	-	55	3	F	?	58
13,210-20	53	3	-	4	-	3	3	-	30	4	F	?	34
13,360-70	51	3	-	4	-	2	2	-	33	5	F	?	38
13,510-20	42	3	-	8	-	12	-	-	31	4	F	?	35
13,810-20	56	3	2	5	-	3	2	-	25	4	F	?	29
13,960-70	60	3	-	3	-	2	2	-	27	3	F	?	30

Table 1.--Mineral composition by weight percent X-ray diffraction, COST No. G-1 well -- continued

Depth(Feet)	Quartz	Feldspar	Calcite	Dolomite	Siderite	Anhydrite	Pyrite	Kaolinite	Illite	Chlorite	Mixed-Layered Illite/Montmorillonite	% Expandable	% Clays
14,100-10	42	7	-	3	-	2	2	-	42	2	F	?	44
14,260-70	49	5	-	12	-	2	3	-	25	4	F	?	29
14,560-70	43	4	3	7	-	2	2	-	35	4	F	?	39
14,710-20	52	3	-	20	-	2	1	-	18	4	F	?	22
14,860-70	41	8	2	10	-	-	2	-	32	5	F	?	37
15,010-20	50	4	3	11	-	2	4	-	23	3	F	?	26
15,160-70	48	3	4	9	-	2	2	-	28	4	F	?	32
15,310-20	58	5	2	4	-	2	4	-	22	3	F	?	25
15,910-20	73	5	-	-	-	4	-	-	12	6	F	?	18
16,050-60	69	4	-	-	-	3	6	-	15	3	F	?	18

CORE DESCRIPTIONS AND ANALYSES

By David J. Lachance and Roger V. Amato

Six conventional diamond coring attempts produced five partial recoveries. The cored intervals and recoveries are as follows:

Core Number	Cored Interval (feet)	Attempted (feet)	Recovered (feet)
1	5,121- 5,143	22	0
2	5,469- 5,489	20	12
3	9,980-10,006	26	23
4	12,897-12,947	50	44.7
5	13,929-13,944	15	11.6
6	16,051-16,071	20	12

Analyses were made only on Cores 2, 3, and 5 by Core Laboratories, Inc. (1976) on 1-inch diameter cylindrical samples taken from each foot of sandstone. Core analysis measurements were not made on Cores 4 and 6 because of lack of visible porosity and potential reservoir rock.

Core 2 (fig. 7) consists of sandstone, shale and mudstone. The sandstone is light-gray to white, medium- to fine-grained, well-sorted, friable to moderately indurated, with angular to subangular grains and cement type ranging from slightly siliceous to highly calcareous. Minor to moderate amounts of pyrite, lignite, hematite, chlorite, muscovite and clays are also present. The mudstone and shale are dark gray, well indurated, and calcareous. They contain mudclasts, faint bedding planes, and ghosts of mudclasts as light-brown areas along with concentrated masses of pyrite, lenses of siltstone, and fossils including pelecypods and gastropods. Porosity measurements in the sandstone section ranged from 18 to 36 percent and permeability measurements from 413 to 8010 millidarcys.

Core 3 (fig. 7) consists of limestone, sandstone, mudstone, and siltstone; the upper part of the core is predominantly limestone and the lower part sandstone. The limestone is medium- to dark-gray, fossiliferous, very fine-crystalline to pelletal calcirudite (oolitic biosparite) and calcarenite

CORE ANALYSIS RESULTS—CORE NO. 2 *

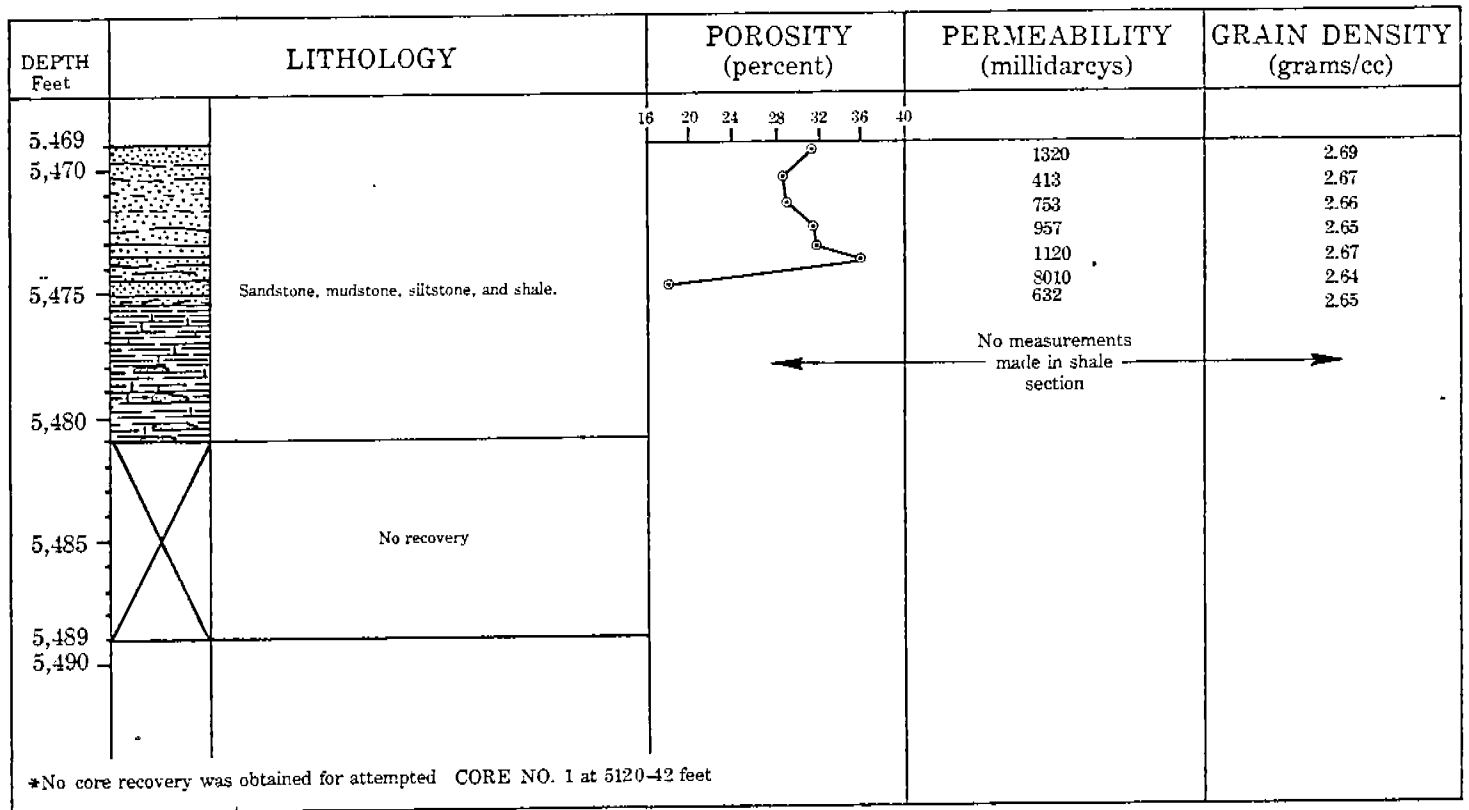

CORE ANALYSIS RESULTS—CORE NO. 3

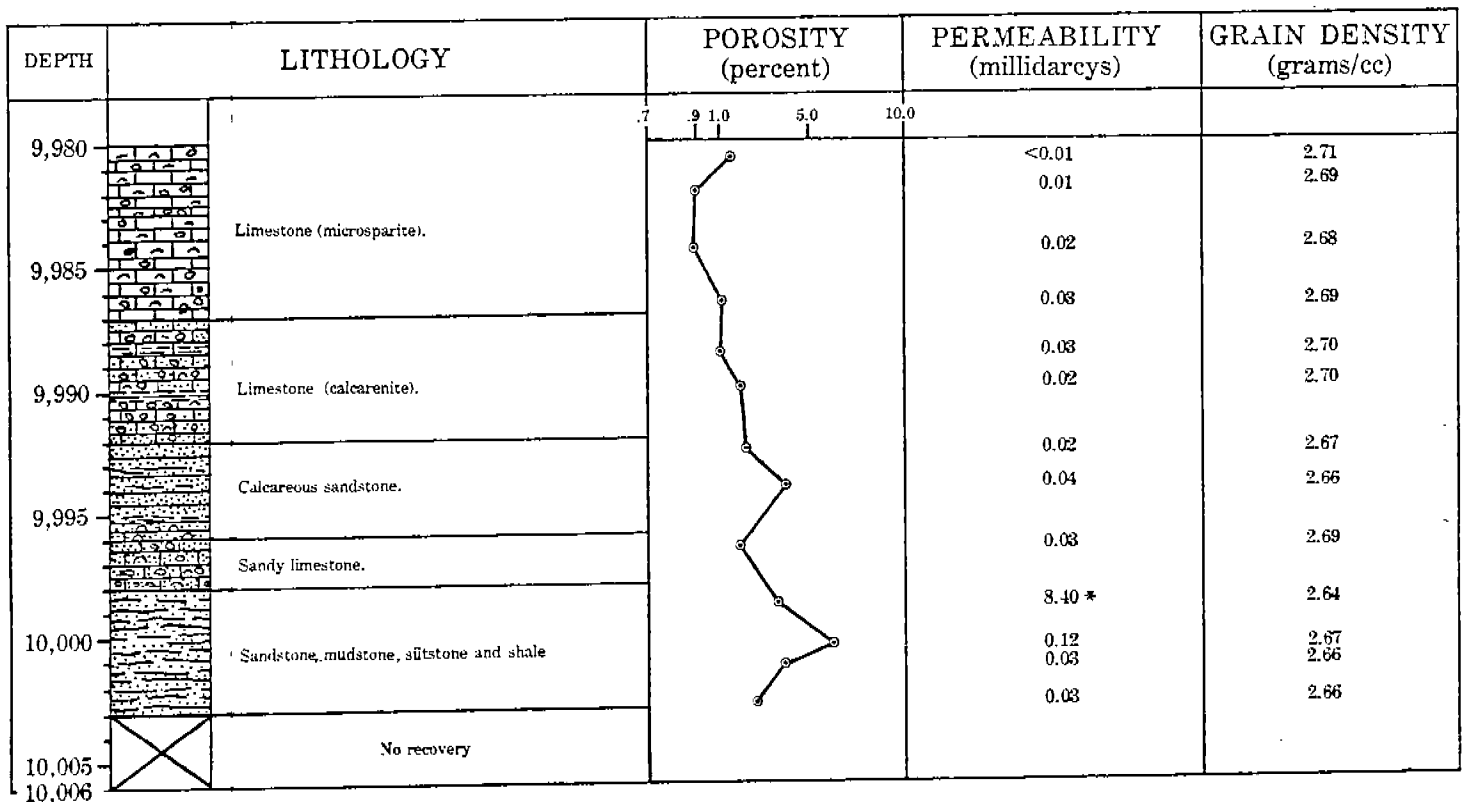

*Fracture probably contributing to high permeability measurement.

Figure 7. Core data summaries for conventional cores 2 and 3

with interlaminated layers of medium- and dark-gray limestone throughout the interval and traces of mica and pyrite. Layers of deformed intraclasts and stringers of black gilsonite also occur on the bedding planes. The sandstone ranges from light- to dark-gray, is fine-grained, and has equant to subangular and subrounded grains in calcareous cement. The mudstone and siltstone are light- to dark-gray, well indurated and calcareous; some layers are crossbedded and disrupted by burrowing. Measurements were made at 13 points on the core for porosity and permeability measurements. Porosity ranged from 0.9 to 6.0 percent and permeability from less than 0.01 to 0.12 millidarcys. One anomalously high reading of 8.4 millidarcys is attributed to a small fracture in the core.

Core 4 (fig. 8) is a complex mixture of anhydrite, dolomite, and mudstone. The anhydrite is red, light- to dark-gray, pink, and white, fine to very fine crystalline, and nodular to massive; much of it is interlaminated and mixed with dark-gray, black, red and brown mudstone and gray-green claystone. Small anhydrite nodules are scattered through most of the mudstone and claystone. Some massive anhydrite layers show a pronounced chicken-wire structure, with dark-gray mudstone filling the cracks. The dolomite is tan, brown, and light-gray and fine-crystalline with wavy to even interlaminations of dark-gray mudstone.

Core 5 (fig. 9) consists of sandstone, conglomerate, and mudstone. The sandstone is light- to medium-gray and reddish brown, poorly to well sorted, has equant to subelongated grains which are angular to subrounded, and is very fine- to medium-grained and well- to moderately-indurated with both siliceous and calcareous cement. The conglomerate is reddish-brown to buff and poorly to very poorly sorted with equant to subelongated grains which are subangular to rounded with both calcareous and silica cement. Minor amounts of dark minerals (specular hematite, glauconite, and mica) give the conglomerate a granitic appearance. The mudstone is dark reddish-brown, well-indurated, and finely laminated with interbedded layers of siltstone and claystone. Porosity measured from four points

DEPTH Feet	LITHOLOGY	POROSITY* (percent)	PERMEA- BILITY* (millidarcys)	GRAIN DENSITY* (grams/cc)
12,897	Crystalline anhydrite with mudstone.			
12,900				
12,905	Dolomite			
	Anhydrite with mudstone layers.			
12,910	Dolomite			
	Crystalline anhydrite with mudstone inclusions.			
12,915	Crystalline anhydrite			
12,920	Nodular anhydrite intermixed with mudstone and dolomite.			
	Dolomite			
12,925	Mudstone with nodular anhydrite.			
	Dolomite			
12,930	Mudstone with nodular anhydrite.			
12,935	Chicken-wire structured anhydrite and mudstone.			
12,940	Mudstone with lenses of anhydrite.			
	Nodular anhydrite			
	Chicken-wire and massive anhydrite.			
12,945	No Recovery			
12,947				

* Core analysis measurements not made due to visible lack of porosity.

Figure 8. Core data summary for conventional core 4

CORE ANALYSIS RESULTS—CORE NO. 5

DEPTH Feet	LITHOLOGY	POROSITY (percent)	PERMEABILITY (millidarcys)	GRAIN DENSITY (grams/cc)
13,929 13,930	Sandstone	6.0	0.12	2.71
		5.5	0.12	2.70
13,935	Sandstone and conglomerate with small mudstone lenses.	4.5	0.11	2.69
	Mudstone with interbeds of siltstone.			
13,940	Sandstone	8.5	0.12	2.75
13,944	No Recovery			

CORE ANALYSIS RESULTS—CORE NO. 6

DEPTH	LITHOLOGY	POROSITY* (percent)	PERMEABILITY* (millidarcys)	GRAIN DENSITY * (grams/cc)
16,051 16,055	Phyllite with quartz veins.			
16,060				
16,065	No Recovery			
16,070 16,071				

* Core analysis measurements not made due to visible lack of porosity.

Figure 9. Core data summaries for conventional cores 5 and 6

on the core ranged from 4 to 8 percent and permeability averaged 0.12 millidarcys.

Core 6 (fig. 9) was obtained from the bottom of the well in basement rock. It consists of black to light-gray phyllite and quartz-mica (muscovite and sericite) schist with minor amounts of pyrite, calcite, and black carbonaceous (graphite?) material. The quartz is white to light-gray and occurs as masses, wedges, layers, and fracture fillings. Pyrite occurs as small cubes, masses, and crack fillings. The rock is generally well-foliated; graphitic material occurs on the foliation faces. Most of the rock is highly contorted.

Analyses by Core Laboratories, Inc. (1976) of 117 sidewall core samples collected throughout the well provide a complete series of porosity and permeability values for sandstones. Permeability determinations were made empirically by comparison with a chart compiled from analyses of conventional sandstone cores and sidewall cores. Porosities were determined by the "summation of fluids" method. Grain densities were calculated from the core analysis data. These data are listed in table 2 and plotted in figures 10, 11 and 12. Porosity and permeability measurements correlate closely (fig. 10). Both porosity and permeability generally decrease with depth as compaction increases (figs. 11 and 12). The broad range of values reflects variations in shale content and types of cement.

Minor amounts of gas were detected in sidewall cores taken in the well between 4,000 and 10,000 feet. However, none of the gas detections were judged to indicate gas accumulations.

In the upper part of the well (above 4,000 feet), porosity values determined from electric logs vary widely from porosity values determined from core analyses. As depth increases the values converge and differ by only a few percent at approximately 5,000 feet. The converging is due to increased compaction and decreased permeability, resulting in less mudcake buildup around the borehole and hence increased accuracy in the electric logs.

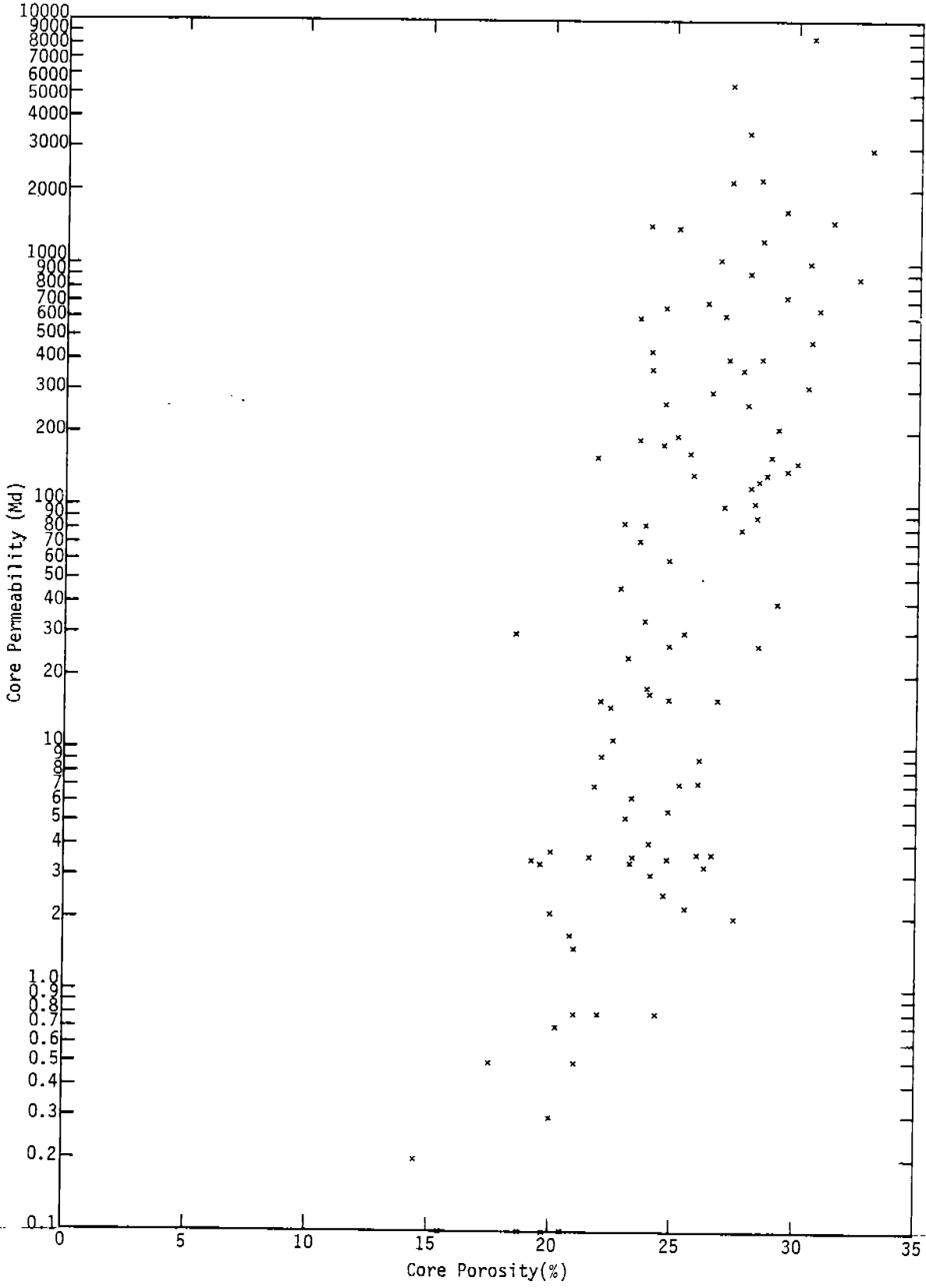

Figure 10. Core porosity versus permeability for the COST No. G-1 well

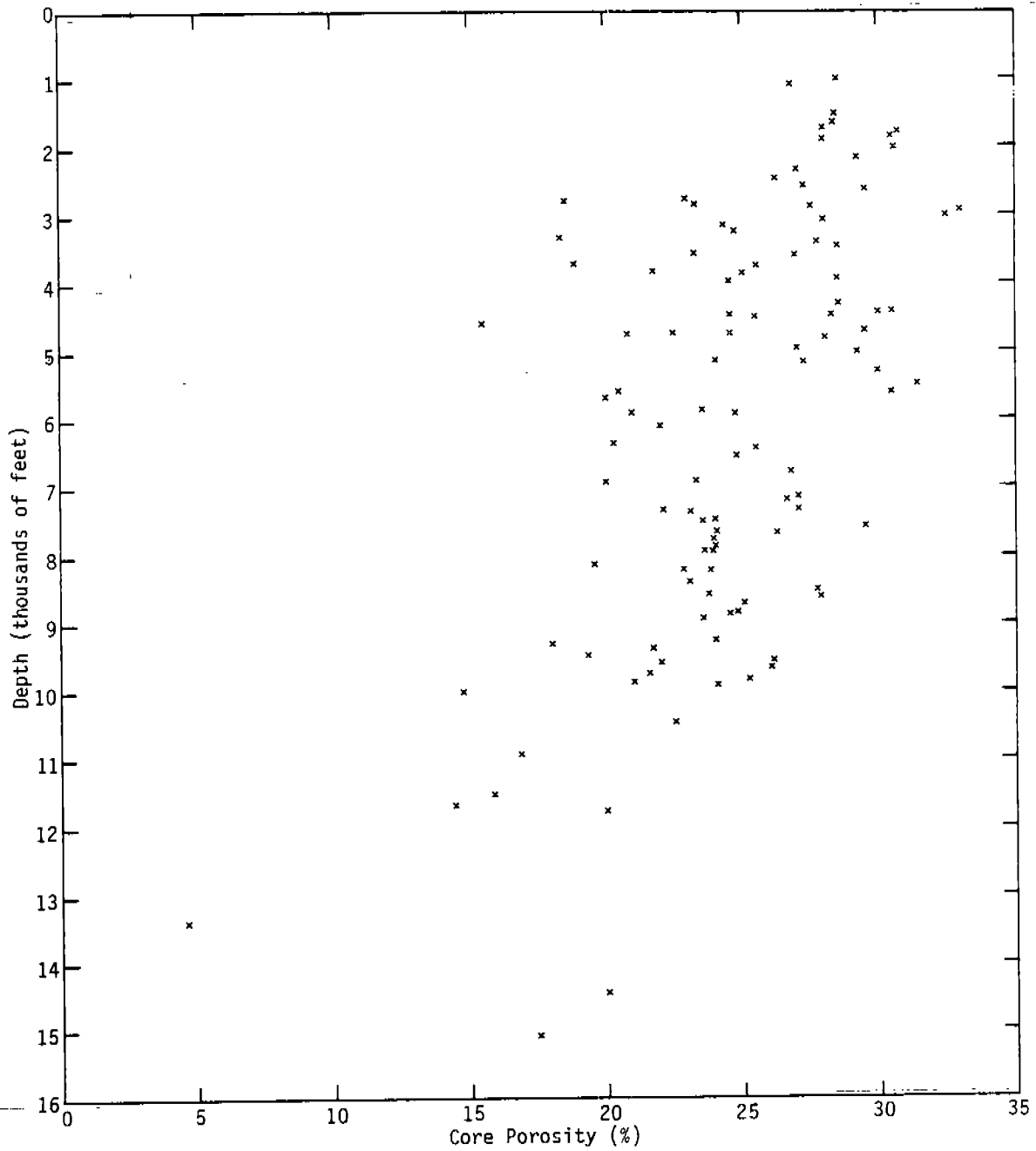

Figure 11. Core porosity versus depth for the COST No. G-1 well

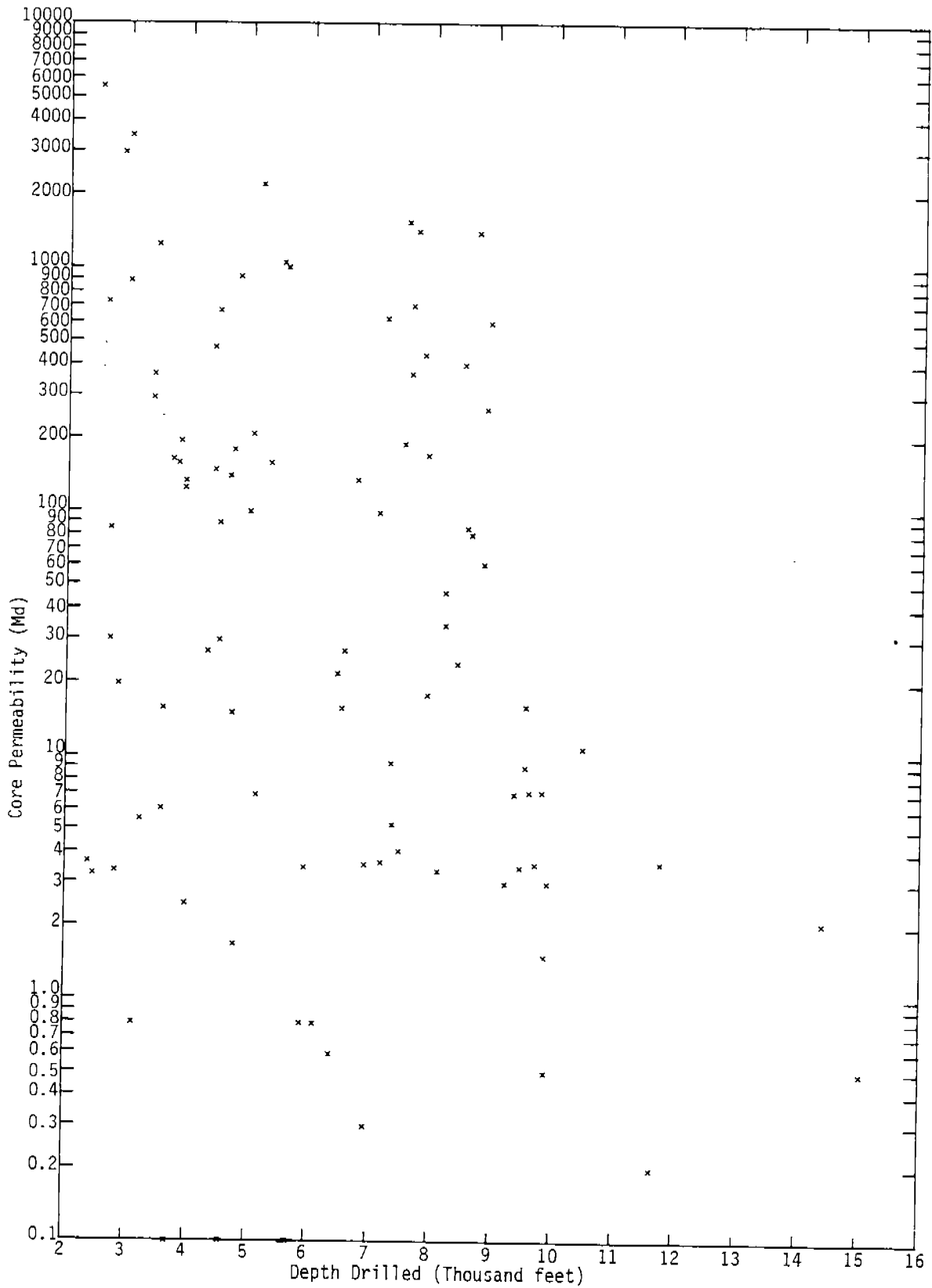

Figure 12. Core permeability versus depth for the COST No. G-1 well

Table 2-- Side wall core analysis results. Dominant lithology at all listed depths is sandstone.

Depth (feet)	Permeability (millidarcys)	Porosity (per cent)
993.0	420	28.5
1079.0	1050	26.8
1514.0	2250	28.4
1628.0	105	28.3
1695.0	120	28.1
1750.0	650	30.7
1822.0	310	30.4
1889.0	265	27.9
2001.0	8600	30.6
2149.0	40	29.2
2363.0	3.7	26.9
2429.0	3.3	26.2
2530.0	5500	27.2
2623.0	740	29.5
2725.0	86	22.9
2769.0	30	18.5
2819.0	3.4	23.2
2850.0	20	27.6
2899.0	2950	33.1
2994.0	880	32.6
3032.0	3500	27.9
3119.0	0.8	24.3
3230.0	5.5	24.7
3293.0	0.1	18.3
3346.0	295	26.6
3360.0	370	27.7
3439.0	1250	28.5
3561.0	6.3	23.2
3575.0	16	26.8
3693.0	0.1	18.8
3727.0	165	25.6
3813.0	160	21.8
3864.0	195	25.1
3929.0	125	28.4
3942.0	135	28.8
3964.0	2.5	24.6
4292.0	27	28.5
4388.0	475	30.6
4422.0	150	30.0
4432.0	670	24.6

Depth (feet)	Permeability (millidarcys)	Porosity (per cent)
4475.0	90	28.3
4505.0	30	25.5
4583.0	0.1	15.5
4656.0	140	29.6
4722.0	180	24.5
4733.0	15	22.4
4764.0	1.7	20.8
4780.0	910	28.1
4940.0	100	27.0
5021.0	210	29.2
5113.0	17	24.0
5160.0	2200	27.2
5285.0	160	28.9
5474.0	1050	31.4
5593.0	0.1	20.5
5604.0	1000	30.4
5682.0	0.1	19.8
5861.0	0.1	23.5
5871.0	0.8	20.9
5908.0	3.5	24.7
6071.0	0.8	21.9
6363.0	0.6	20.2
6433.0	22	25.5
6524.0	16	24.8
6559.0	27	24.8
6747.0	135	26.7
6895.0	3.6	23.3
6914.0	0.3	20.0
7109.0	99	27.0
7155.0	3.7	26.6
7184.0	620	27.1
7323.0	9.3	22.1
7359.0	5.2	23.1
7460.0	4.1	24.0
7484.0	190	23.5
7560.0	1650	29.5
7626.0	370	24.1
7669.0	700	26.3
7723.0	1430	23.9
7834.0	440	24.0
7908.0	73	23.6

Table 2--Sidewell core analysis results-- continued.

Depth (feet)	Permeability (millidarcys)	Porosity (per cent)
7928.0	18	23.9
8094.0	3.4	19.6
8183.0	47	22.8
8195.0	34	23.8
8381.0	24	23.1
8511.0	405	27.2
8548.0	85	23.7
8606.0	80	27.8
8685.0	1400	25.1
8816.0	61	24.8
8867.0	265	24.6
8917.0	600	23.5
9223.0	3.0	24.1
9273.0	0.1	17.9
9363.0	7.0	21.7
9443.0	3.5	19.3
9520.0	9.0	26.1
9554.0	16	21.9
9625.0	7.2	26.0
9712.0	3.6	21.6
9802.0	7.2	25.2
9866.0	1.5	20.9
9868.0	0.5	21.1
9886.0	3.0	24.1
9971.0	0.1	14.7
10459.0	11	22.5
10925.0	0.1	16.8
11498.0	0.1	15.8
11634.0	0.2	14.4
11761.0	3.8	19.9
13377.0	0.1	4.6
14420.0	2.1	19.9
15065.0	0.5	17.5

BIOSTRATIGRAPHY

By William E. Steinkraus

Age and paleoenvironmental determinations for the COST No. G-1 well are based on the paleontological analysis of 352 sidewall and conventional core samples, and on an examination of 500 well cuttings samples, by International Biostratigraphers, Inc. (1976). In addition, L.A. Latta (written commun., 1976) of the USGS in Metairie, La., made a biostratigraphic study of numerous cuttings samples collected throughout the well and verified the paleontological data discussed here.

The COST No. G-1 well was determined to have penetrated about 775 feet of shallow-marine lower Tertiary strata (Recent through Eocene sediments were not identified) and approximately 1,650 feet of shallow-to deep-water marine Upper Cretaceous strata. About 13,320 feet of the section was comprised of terrestrial to moderately deep-water Lower Cretaceous and Jurassic sediments.

Table 3 shows the depths to the tops of the geologic systems, series and/or stage represented in the COST No. G-1 well.

Table 3.--Summary of the depths to the tops of the geologic system series and/or stage represented in the COST G-1 No. well

<u>Depth (feet)</u>	<u>Geologic System, Series or Stage</u>	
255	Sea floor - no samples collected	
1,013	In Paleocene	
1,030	Santonian	--Upper Cretaceous
1,650	Coniacian?	
1,859	Turonian	
2,343	Cenomanian	
2,680	Albian-Aptian	--Lower Cretaceous
3,274	Aptian	
3,800	Barremian-Valanginian	
5,070	Berriasian	
5,290	Tithonian	--Upper Jurassic
5,699	Kimmeridgian-Oxfordian	
10,100	Callovian	--Middle Jurassic
14,000	Toarcian	--Lower Jurassic
*15,630	Cambrian? (450-550 m.y. K/Ar age)	
16,071	(T.D.)	

*Lithologic and seismic evidence indicates that metamorphic basement rock may top at this level.

Age Determinations

The Paleocene age for the uppermost portion of the COST No. G-1 well was assigned entirely from the fossil dinoflagellates present, but the Upper Cretaceous section was interpreted on the basis of foraminifers, calcareous nannofossils, and palynomorphs (spores and pollen). The Lower Cretaceous and Jurassic sections of the well were dated and analyzed mainly from palynomorph assemblages and from nannofossils in the upper stages because foraminifers become sparse in Lower Cretaceous rocks and almost nonexistent in Jurassic samples.

Figure 13 provides a summary and comparison of the age interpretations indicated by the various biostratigraphic analyses completed for the COST No. G-1 well (foraminifers, calcareous nannofossils, and palynomorphs). These data were combined to create the "Assumed Age (composite)" indicated on the left side of the table.

Tertiary (1,013-1,030 feet)

Paleocene (1,013-1,030 feet)

The shallowest strata sampled by sidewell cores contained assemblages with abundant dinoflagellates and were interpreted as Paleocene in age based on the presence of such species as Kenleyia cf. K. lophophora, Deflandrea cf. D. diebeli, Deflandrea speciosa, and Paleoperidinium pyrophorum. A single specimen of the Cretaceous bisaccate pollen Rugubivesiculites rugosus was noted in the 1,013-foot sample, but it is probably reworked.

Cretaceous (1,030-5,290 feet)

Santonian (1,030-1,650 feet)

Palynomorphs: The Santonian age is based on fairly abundant assemblages of Upper Cretaceous dinoflagellates; such species as Chatangiella

	ASSUMED AGE (composite)	FORAMINIFERS	PALYNOMORPHS	CALCAREOUS NANNOFOSSILS		
	PALEOCENE		PALEOCENE			
1	SANTONIAN	CAMPANIAN TO SANTONIAN	SANTONIAN	SANTONIAN-CONIACIAN		
	CONIACIAN?		CONIACIAN?	(BARREN)		
2	TURONIAN	TURONIAN	TURONIAN	TURONIAN		
	CENOMANIAN	(BARREN)	CENOMANIAN?	CENOMANIAN		
3	ALBIAN-APTIAN		ALBIAN-APTIAN	(BARREN)		
	APTIAN		APTIAN?	APTIAN		
4	BARREMIAN TO VALANGINIAN	(BARREN)	BARREMIAN TO BERRIASIAN	(BARREN)		
5	BERRIASIAN		BERRIASIAN			
	TITHONIAN	TITHONIAN?	TITHONIAN	TITHONIAN		
6	KIMMERIDGIAN TO OXFORDIAN	(BARREN)	KIMMERIDGIAN TO OXFORDIAN	KIMMERIDGIAN- CALLOVIAN		
7						
8						
9						
10	MIDDLE JURASSIC	(BARREN)	MIDDLE JURASSIC	(BARREN)		
11						
12						
13	EARLY JURASSIC?	(BARREN)	EARLY JURASSIC?	(BARREN)		
14						
15	CAMBRIAN?		UNKNOWN AGE			
16						

Figure 13. Summary and comparison of the age interpretations indicated by the various biostratigraphic analyses completed for the COST No. G-1 well

victoriensis, Dinogymnium westralium, Dinogymnium euclaensis, Paleohystrichophora infusorioides, and Surculosphaeridium longifurcatum make their first appearance in the interval between 1,100 and 1,650 feet. According to the range chart for Upper Cretaceous dinoflagellates published by Evitt (1975), Chatangiella victoriensis is restricted to the Santonian, although Williams (1974) does show it ranging up into the Campanian of the Grand Banks and Scotian Shelf wells.

Also present in this interval are rich assemblages of typically Cretaceous spores and pollen, including species such as Appendicisporites tricornatus, "Classopollis classoides", and Rugubivesiculites rugosus.

Nannofossils: The highest well cuttings sample examined at 1,030 feet contains a sparse, although moderately diverse calcareous nannofossil assemblage including Eiffellithus trabeculatus, Lithastrinus grilli, and Nannoconus sp. Marthasterites furcatus and Eiffellithus eximius are present in the sidewall core taken from 1,072 feet. The joint occurrence of the nannofossil species Marthasterites furcatus and Eiffellithus trabeculatus indicates a Santonian age for this interval.

Foraminifera: The foraminiferal fauna present in the sidewall core from 1,172 feet is sparse; Inoceramus prisms have been observed in the sample along with the several foraminifers. A few planktonic species such as Globotruncana fornicata and Globotruncana lapparenti were identified in lower cores within the interval. The latter species can, at best, indicate a Campanian to Turonian interval.

Coniacian? (1,650-1,859 feet)

In this interval, the spore/pollen and dinoflagellate assemblages are very similar to those described in the interval above but are somewhat richer.

A probable upper limit for the Coniacian stage was placed at the highest occurrence of the pollen species Complexiopollis cf. C. funiculus, a form which Tschudy (1973) indicates does not range above that stage.

In addition, the dinoflagellate Chatangiella victoriensis was not observed in this interval, and its absence may be considered indicative of a pre-Santonian age. Also present in this interval were distinctive, undescribed species of the dinoflagellate genera Diconodinium, Leptodinium, and ? Canningia. These species may prove to be characteristic of this horizon.

Turonian (1,859-2,343 feet)

Foraminifera: The planktonic assemblages from this interval are rich and moderately diverse, and are characterized by the species Globotruncana helvetica, Globotruncana schneegansi, and Praeglobotruncana turbinata. The benthonic component of the assemblages is not well developed, but such genera as Epistomina, Conorboides and Marssonella have their highest occurrence in this interval.

The age assignment is based on the occurrence of the planktonic foraminifera Globotruncana helvetica, which is present in sidewall cores from 1,941 to 2,325 feet.

Palynomorphs: Numerous dinoflagellate species, including Cyclonophelium vannophorum, Dinopterygium cladoides, and Coronifera oceanica have their highest occurrences in the samples from 1,941, 1,956, and 1,964 feet; only the species Coronifera oceanica, however, has not been commonly reported from post-Turonian horizons. According to Evitt (1975), it does not range above the Turonian, although Williams (1974) records it from the Coniacian of the Grand Banks and Scotian Shelf of Canada.

Evidence from the spores and pollen present in this interval is less definitive. Several species originally described from the Cenomanian, for example Phyllocladidites inchoatus, have their highest occurrence here. The range of this species has not yet been well established, however, and this occurrence here together with the Turonian foraminifera Globotruncana helvetica strongly suggests that it ranges upward at least as high as that stage.

Nannofossils: An age no younger than Turonian is interpreted from the highest occurrence of Corollithion achylosum in the sidewall core at 1,859 feet together with the lowest occurrence of Micula decussata at 1,841 feet.

Cenomanian (2,343-2,680 feet)

Palynomorphs: Many of the dinoflagellates observed in higher samples are again present in this interval. The dinoflagellate species Cribroperidinium edwardsii and Epelidosphaeridia spinosa, however, have their highest occurrences at 2,343 and 2,403 feet, respectively, and this indicates an age not younger than Cenomanian. A few specimens of Gonyaulacysta cf. G. exilicristata, a species first described from the Cenomanian of England were noted, and this also tends to support a Cenomanian age interpretation.

Other dinoflagellates having their highest occurrences here, but which are known from younger strata elsewhere, are Hystrichosphaeridium stellatum (sensu Williams and Brideaux, 1975), Litosphaeridium siphoniphorum, and Odontochitina operculata.

Also present in this interval, although rare, are the highest occurrences of the primitive angiosperm pollen Retitricolpites georgensis and Clavatipollenites hughesi. Neither of these species has been reported from sediments younger than Cenomanian.

Nannofossils: A Cenomanian age is based on the occurrence of Podorhabdus albianus present in the sidewall cores from 2,343 and 2,353 feet, also from a well cuttings sample from 2,350 to 2,380 feet.

Albian-Aptian? (2,680-3,274 feet)

A probable upper limit for the Albian stage was placed at the lowest occurrence of the dinoflagellate species Surculosphaeridium longifurcatum. According to Evitt (1975), this species has not been reported from sediments older than mid-Albian. It is also roughly at this

level that the environment of deposition changes from marine to predominantly nonmarine (L. A. Latta, written commun., 1976). No occurrences of foraminifera and nannofossils have been reported in the sidewall cores from this interval.

Palynomorphs: The sparse dinoflagellate assemblage within the interval is contained in a single sidewall core at 2,977 feet. The species Exochosphaeridium striolatum has its lowest occurrence in the Albian.

The sidewall sample from 3,076 feet is very rich and diverse in spore and pollen species. Gymnosperm pollen such as Araucariacites australis, Parvisaccites radiatus, and Phyllocladidites microreticulatus is common, and Rugubivesiculites rugosus, Klukisporites pseudoreticulatus, Contignisporites cooksonii are present, although rare. The last species has not been reported from sediments younger than Albian, and the first is not known from pre-Albian horizons; thus, this level is interpreted as Albian in age.

Aptian (3,274-3,800 feet)

Because of a sample gap between 3,076 and 3,274 feet, the top of the Aptian stage has not been determined. The sample from 3,274 feet, however, yielded a good, well-preserved assemblage of spores and pollen indicative of an age not younger than Aptian: Trilobosporites variverrucatus, Pilosisporites trichopapillosus, Contignisporites cooksonii, and Coronatispora valdensis. At that same level, rare Inoceramus prisms and fragments of the foraminifera Epistomina and Frondicularia have been recovered. From this depth down to 3,634 feet, Trochammina, Robulus, Astacolus, Lenticulina, as well as ostracods, microgastropods, echinoid spines, and shell fragments are present.

Palynomorphs: Assemblages from 3,286 and 3,288 feet contained age diagnostic dinoflagellates as well as spores and pollen: Cribroperidinium edwardsii, Oligosphaeridium complex, and "Cyclonephelium" tabulatum was described from the Aptian type section by Davey and Verdier (1974), and

has not been reported from older or younger sediments.

The dinoflagellate species Meiourogonyaulax stoverii and Gardodinium eisenacki make their first appearance in the G-1 sediments in a sample from 3,671 feet, and their presence here suggests an early Aptian age.

Foraminifera: The benthonic foraminifera Lenticulina subalata has been identified from the sidewall core at 3,600 feet. This form may be conspecific with Lenticulina nodosa which has been reported from the Aptian of eastern Canadian offshore wells.

Nannofossils: At 3,477 feet, the calcareous nannofossil Nannoconus bucheri has its highest occurrence. In the sidewall core of 3,600 feet, Nannoconus bucheri occurs together with Cyclagelosphaera margereli, Helenia chiasta, and Micrantholithus obtusus.

The joint occurrence of these forms, as well as the presence of the formamifer Lenticulina subalata, indicates an age not younger than early Aptian for the sediments at this level. From 3,600 to 3,745 feet, the assemblages are generally the same.

Barremian - Valanginian (3,800-5,070 feet)

The lowest common occurrence of the Aptian dinoflagellate species "Cyclonephelium" tabulatum is in a sidewall core from 3,671 feet, and the Aptian-Barremian boundary has been placed at 3,800 feet.

A few specimens of this species were noted in the sidewall cores from 4,007, 4,047, and 4,438 feet; their presence at those levels, however, suggests that either the Aptian-Barremian boundary has been placed too high, or that "Cyclonephelium" tabulatum ranges downward into the upper Barremian.

Except for the sidewall cores from 4,007 and 4,047 feet, dinoflagellates are very scarce in the 23 samples studied from 3,671 and 5,070 feet, and the spores and pollen of this largely nonmarine interval are all long-ranging Lower Cretaceous species of little chronostratigraphic value. The dinoflagellates Chlamydothorella nyei, Subtilisphaera perlucida, Isabelia

cretacea, and Coronifera oceanica all have their lowest occurrences in the sample from 4,047 feet, suggesting a Barremian age at this level.

Berriasian: (5,070 - 5,290 feet)

Palynomorphs: At 5,070 feet the dinoflagellates reappear, and in addition to Cyclonephelium distinctum and Oligosphaeridium complex, which were observed higher in the well, Systematophora complicata, Muderongia simplex, Achomospaera neptuni, and ? Wanea sp. have their highest occurrence here. All these species have been reported from strata at least as young as Barremian, and are therefore nondefinitive.

Nannofossils: Sidewall cores from 3,600-5,070 feet were barren of calcareous nannofossils. At 5,070 feet, the Berriasian age indicator Polycostella senaria, has its highest occurrence. Because the sidewall cores above this depth are barren, the top of the Berriasian may possibly be higher in the well.

Jurassic (5,290-16,000 feet)

Tithonian (5,290 - 5,699 feet)

Palynomorphs: Controversy and subjectivity surround the placement of the Jurassic-Cretaceous boundary when based on micropaleontological evidence. In the G-1 well, the problem has been compounded by the fact that the sidewall cores in this interval yielded only poor palynomorph assemblages.

The dinoflagellate species Ctenidodinium cf. C. panneum has its highest occurrence in a cuttings sample. This species has not been reported from sediments younger than Tithonian. Numerous other dinoflagellate species, including Gonyaulacysta cf. G. longicornis, Imbatodinium villosum, and Pareodinia ceratophora, also have their highest occurrence at this level. All of the previously named species are known to range into the Lower Cretaceous and are therefore nondefinitive.

Several dinoflagellates and spores previously thought to be restrict-

ed to the Cretaceous occur below the inferred Jurassic-Cretaceous boundary. Cyclonephelium distinctum occurs in core 2, and Tanyosphaeridium variecalamum was observed in the sidewall core from 4,531 feet; Pilosporites trichopapillosus was noted in four sidewall cores from below 5,700 feet, and Cicatricosisporites sp. occurs sporadically as low as 7,589 feet. Although some of these rare occurrences may be due to contamination, it appears probable that the ranges of several forms may have to be extended downward into the Jurassic.

Foraminifera: Chips from five intervals in conventional core 2 were processed to recover foraminifers, and good assemblages were recovered from 5,475.8 and 5,478.7 feet. Everticyclammina eccentrica, Epistomina caracolla, Robulus muensteri, Epistomina ornata, Lenticulina cf. L. vacillante, and Spirillina sp. are present at that level. Everticyclammina eccentrica has been described from the Lower Cretaceous in Saudi Arabia and has not been reported from older sediments; most of the other forms, however, are known from both the Jurassic and Cretaceous. The age of core 2 rock, based solely on foraminifers, is interpreted as earliest Cretaceous (Neocomian) to latest Jurassic (Tithonian).

Nannofossils: A sparse nannoflora including Polyodorhabdus escaigi is present in the well cuttings sample at 5,290-5,300 feet. Polycostella beckmanni has been reported from a conventional core at 5,478 feet. A Tithonian age determination is based on the joint occurrence of the above species.

Kimmeridgian-Oxfordian (5,699 - 10,100 feet)

Palynomorphs: The presence of the dinoflagellate species Leptodinium clathratum and ? Egmontodinium sp. at 5,699 feet and Histiophora ornata and Meiourogonyaulax staffinensis at 5,767 feet, suggests a Kimmeridgian age for this level, and the occurrence of Gonyaulacysta jurassica and Meiourogonyaulax bulloidea at 6,543 feet indicates that this horizon is not younger than middle Kimmeridgian. No diagnostic species were noted between

6,784 and 8,398 feet, but a single specimen of Ctenidodinium ornatum in the sidewall from 8,415 feet suggests that this horizon is not younger than middle Oxfordian. Between samples at 8,564 and 9,935 feet, the only occurrences of interest are single specimens of Ctenidodinium ornatum at 9,666 and 9,697 feet, and of Lithodinia jurassica at 9,926 feet.

Only sparse dinoflagellate assemblages were recovered from conventional core 3 between 9,983 and 9,998 feet. Those species present included Hystrichogonyaulax nealei, Gonyaulacysta jurassica, Ctenidodinium cf. C. tenellum, Pareodinia ceratophora, Leptodinium eumorphum, and Meiourogonyaulax bulløidea, indicating an Oxfordian age for this core. At 10,062 feet, a single species Gonyaulacysta dangeardi was observed, and this sidewall is considered to be lowermost Jurassic.

Nannofossils: In the interval between 5,839 and 15,851 feet, 66 sidewall cores were examined as well as conventional cores 3, 4 and 5. All the core samples have been reported to be barren of calcareous nannofossils, however, Late Jurassic forms have been identified in several cuttings samples within the Upper Jurassic section.

An age no younger than lower Kimmeridgian is determined from the occurrence of Stephanolithion bigoti at 5,760-5,770 feet and at 6,400-6,410 feet. Also present are Zeugrhabdotus erectus, Cyclagelosphaera margereli, and Cyclagelosphaera deflandrei.

Middle Jurassic (10,100 - 14,000 feet)

A Middle Jurassic (Callovian) age for this interval is suggested by the presence of the dinoflagellate species Meiourogonyaulax deflandrei and Valensiella vermiculata (Sensu Williams, 1974) in a sidewall core from 10,134 feet. Below 10,171 feet, dinoflagellates are lacking in the assemblages except for rare occurrences of Pareodinia ceratophora at 10,928, 10,990, 11,082, and 13,929.5 feet. None of the spores and pollen present in this interval are particularly age diagnostic, and even most

of the long-ranging species disappear from the samples at around 11,500 feet.

As previously mentioned, however, the dinoflagellate Pareodinia ceratophora is present in conventional core 5 at 13,929 feet; there are no known occurrences of this species below the Middle Jurassic.

Lower Jurassic? (14,000-15,630 feet)

Of the 23 sidewall samples examined from this interval, only seven contained palynomorphs believed to be in place. For the greater part of this interval only one species, "Classopollis classoides" (a form which has been reported from sediments as old as uppermost Triassic), could be definitely recognized.

A sample from 15,909 feet yielded a few specimens of the long-ranging pollen genera Exesipollenites and Inaperturopollenites, and two specimens resembling Callialasporites dampieri, a form not believed to occur below the Middle Jurassic. The specimens of Callialasporites dampieri are poorly preserved, however, and are not typical of that species; consequently, they are not considered to be stratigraphically significant. Thus, there is little palynological evidence upon which to base an age interpretation for this interval. The Early Jurassic (?) age assignment is based largely upon the occurrence of Classopollis classoides and the absence of the dinoflagellate species Pareodinia ceratophora. But since no other dinoflagellates are present, and because Classopollis classoides is known to range downward into the Upper Triassic, this interpretation must be considered highly speculative.

Cambrian (15,630-16,061.4 feet)

Ditch cuttings samples from 16,000 to 16,050 feet and a "bottoms up" sample from 16,050 feet were examined palynologically, and only a very few specimens of Classopollis classoides were observed. Their state of

preservation resembled that of specimens noted higher in the well, and their presence was attributed to caving.

Three chips from the highly fractured, black, graphitic schist penetrated by conventional core 6 (16,056 to 16,061.4 feet) were carefully processed and studied, but no palynomorphs were recovered. Consequently, the age of this metamorphic rock cannot be determined palynologically. However, three samples were subjected to a K-Ar age determination by Krueger Enterprises, Inc. (written commun., 1976). The three samples gave apparent ages ranging from 450 million to 550 million years, and the character of the material suggests that the 550-million-year estimate (Cambrian) most likely represents the correct "metamorphic" age. Two of the samples, which gave the younger age, contained coarsely crystalline quartz/feldspar lenses, while the sample dated as 550 million years was fine-grained phyllite. The coarse quartz/feldspar material probably lost some argon since recrystallization and, therefore, gave younger apparent ages.

DEPOSITIONAL ENVIRONMENTS

By David J. Lachance, John W. Bebout and LeRon Bielak

Paleontologic, lithologic, and geochemical analyses of the COST No. G-1 well cuttings and cores have been applied to the determination of the environments of deposition.

Paleontologic Analyses

Paleoenvironmental interpretations for the COST No. G-1 well are based on benthonic and planktonic foraminifers and the presence, or absence, of planktonic fossils such as the calcareous nannofossils and dinoflagellates. Where foraminifers are not found, for example, a marine environment may be indicated by the presence of dinoflagellates and/or nannofossils. Samples containing only land-derived palynomorphs are interpreted as non-marine. Paleobathymetry (water depth of sediments at the time of deposition) was inferred by comparing the benthonic fossil foraminiferal assemblages with recent faunas known to favor certain ecological conditions. Understandably, these interpretations are less accurate for older, or sparse, faunas. Figure 14 contains a composite paleoenvironmental interpretation for the various geologic series and/or stages represented in the G-1 well. Also included is a summary of the micropaleontological analyses from which these data were derived (dinoflagellates and calcareous nannofossils are only described in terms of presence or absence and diversity of assemblages).

The three highest sidewall cores examined by International Biostratigraphers, Inc. (1976), were barren of foraminifers. L. A. Latta (USGS, written commun., 1976) however, did observe a sparse foraminiferal assemblage in a sample from 1,030 feet, which he interpreted as representative of an inner-neritic environment with water depths ranging from 0 to 50 feet. Between 1,172 and 1,921 feet, benthonic foraminifers continue to be sparse. Species present indicate that sediment deposition occurred in a shallow-marine environment with water depths of 100-300 feet. Also present within this interval are good dinoflagellate and calcareous nannofossil assemblages.

	GEOLOGIC EPOCHS/AGES	PALEO-ENVIRONMENT (composite)	FORA-MINIFERS	NANNO-FOSSILS	DINO-FLAGELLATES	
1	PALEOCENE	*	INNER SHELF, 0-50'			
2	SANTONIAN?	INNER TO MIDDLE SHELF, 0-300'	I-II	MIDDLE SHELF, 50-300'	GOOD ASSEMBLAGES	GOOD ASSEMBLAGES
	CONIACIAN					
3	TURONIAN	OUTER SHELF 300-600'	III	OUTER SHELF, 300-600'	ABSENT	POOR ASSEMBLAGES NO SAMPLES
	CENOMANIAN	TERRESTRIAL TO MIDDLE SHELF, 0-300'	I-II	MIDDLE SHELF, 50-300'		
4	ALBIAN-APTIAN	INNER SHELF, 0-50'	I	ABSENT	POOR ASSEMBLAGE	GOOD ASSEMBLAGES
	APTIAN					
5	BARREMIAN TO VALANGINIAN	TERRESTRIAL	---	ABSENT	ABSENT	ABSENT
6	BERRIASIAN	MIDDLE SHELF, 50-300'	II	MIDDLE SHELF, 50-300'	POOR ASSEMBLAGES	
	TITHONIAN	INNER SHELF, 0-50'	I	INNER SHELF, 0-50'		
7	KIMMERIDGIAN TO OXFORDIAN	TERRESTRIAL TO MIDDLE SHELF, 0-300'	I-II	ABSENT	ABSENT	NUMEROUS MARINE INTERCALATIONS, SOME WITH GOOD DINOFLAGELLATE ASSEMBLAGES
				MIDDLE SHELF, 50-300'		
				ABSENT		
8				INNER SHELF, 0-50'		
				ABSENT		
9				TIDAL FLAT		
10	MIDDLE and EARLY JURASSIC?	TERRESTRIAL	---	ABSENT		ABSENT
16						

*USGS ECOLOGIC ZONE NUMBERS

Figure 14. Summary of the paleoenvironmental interpretations for the various geologic epochs and/or ages represented in the COST No. G-1 well

Between 1,941 and 2,325 feet, foraminiferal evidence suggests that water depth increased over the preceding interval. Benthonic foraminifera genera, and the increasing planktonic foraminiferal fauna, indicate water depths in the range of 300-600 feet. As in the previous interval, samples produced good dinoflagellate and calcareous nannofossil assemblages. Sidewall cores from 2,343 and 2,353 feet yielded sparse foraminiferal assemblages. The paucity of forms in these two cores suggests a shallowing of the environment relative to that of the overlying interval.

Between 2,371 and 3,274 feet, most samples are barren of foraminifera, dinoflagellates and calcareous nannofossils, and the depositional environment is largely interpreted as nonmarine. Numerous marine intercalations do occur, however, some producing excellent foraminiferal and dinoflagellate assemblages. Sidewall cores from 3,274 to 3,634 feet yielded foraminiferal genera such as Trochammina, Robulus, Astacolus, and Lenticulina, as well as ostracodes, microgastropods, echinoid spines, and shell fragments, suggesting a middle-shelf environment.

The paucity of specimens, however, points to either environmental stresses limiting the development of the mid-shelf fauna or postdepositional changes altering the biocoenose.

With the exception of a few shell fragments and unidentifiable foraminifera found in sidewall cores at 3,915 and 4,646 feet, the samples examined between 3,634 and 5,050 feet are barren of foraminifera, calcareous nannofossils, and dinoflagellates; thus, this interval is interpreted as nonmarine. At 5,050-5,290 feet, foraminifera reappear although no dinoflagellates or calcareous nannofossils were observed. Everticyclammina type "E", Coskinoloides texanus, Epistomina sp. and the ostracode genus Asciocythere are present there, indicating a middle-shelf environment (50-300 ft. water depth). (L. A. Latta, personal communication, 1976).

The interval from 5321-5709 feet is the last in the well to provide any significant returns of foraminifera. The sidewall core at the top of this interval contained a common occurrence of microgastropods. The

sidewall cores at 5475.8 and 5,478.7 feet produced specimens of Everticyclammina, Lenticulina, Robulus, Espistomina and Spirillina. Trochammina, Guttulina and Globulina species are found near the bottom of the interval while micropelecypods, ostracode and shell fragments occur in many of the samples. The fauna present suggests a shallow marine environment, possibly mixed, with a depth range of 0-300 feet.

Because of a general lack of foraminifers, dinoflagellates, and calcareous nannofossils, the interval below 5,799 feet is considered to represent a nonmarine environment. Numerous small marine intercalations are present, however. Although no nannofossils were observed, dinoflagellates occur sporadically to a depth of approximately 10,000 feet. In addition, a sample from 7,600 feet contained the lowest occurrence of the foraminifer species Everticyclammina type "E" and is considered indicative of a middle shelf environment, a sample from 9,080 feet is apparently marginal marine and a sample from 9,970 feet was interpreted by L. A. Latta (written commun., 1976) as representing a "tidal flat --lagoonal to subtidal" environment.

All samples from 10,000 to 16,071 feet were barren of foraminifers, dinoflagellates, and calcareous nannofossils, and have consequently been interpreted as non-marine.

Lithologic Analyses

This discussion follows the lithologic divisions represented in the "Lithology" part of this report.

Section I-A. (1,030-3,745 feet) Shallow marine: The inferred depositional environment is probably like the present environment on Georges Bank. This interpretation is based upon gross lithology and the presence of abundant marine faunal remains, glauconite pellets, and heavy minerals. Sedimentation was probably largely controlled by current movements.

Section I-B. (3,745-4,980 feet) Deltaic to marginal marine with numerous intercalations: This interpretation is based upon the gross lithology, the relative absence of faunal remains and glauconite, and the presence of abundant

coal, amber, feldspar, and numerous heavy minerals.

Section I-C. (4,980-6,250 feet) Marginal marine to middle shelf with numerous intercalations: The inferred depositional environment is based upon gross lithology, coal and plant material in the shales, and the trace constituent assemblage in the sands. Numerous transgressions are indicated.

Section II-A - II-B. (6,250-9,940 feet) Tidal flats to shallow marine with numerous intercalations: Numerous interpretations are possible including a deltaic or purely marine assemblage. However, the available paleontological data indicate that the majority of the section is nonmarine in origin. The reddish-brown shales present appear to have derived their color from oxidation of the gray shales rather than being deposited as primary red sediments. The rapid alternation of red and gray shales may have resulted from the repeated subaerial exposure of tidal muds. The sands appear to be shallow marine and marginal marine due to their dominantly gray color. The dolomites present are considered to be evidence of shallow marine origin.

Sections III-A - III-C, (9,940-11,900 feet) Tidal flats to shallow carbonate banks: This section contains a series of transgressive-regressive sequences with numerous, minor intercalations. The shale and sand are similar to those in sections II-A-II-B. The carbonates present have been deposited on a shallow carbonate bank or platform, as indicated by their color and the presence of numerous pellets and oolites.

Section IV (11,900-12,360 Feet) transitional: This sequence is transitional between sections III and section V-A. The relative absence of pellets and oolites indicates deposition in slightly deeper, lower energy waters than the rocks in the overlying section.

Sections V-A - V-B (12,360-13,610 feet) Sebkhah to shallow marine: This section is believed to be a transgressive-regressive sequence with numerous intercalations deposited in an environment similar to the modern Arabian Gulf. This interpretation is based upon the presence of abundant

chicken-wire anhydrite, abundant red beds and dolomites, trace constituent assemblages present in the sand, and paleontological data.

Sections VI-A - VI-C (13,610-15,630 feet) Continental to sebkha to shallow marine: The sediments encountered in this section are similar to those described in the previous section with an abundant additional facies interpreted to be continental.

Section VII (15,630-16,071 feet). Basement.

Geochemical Analyses

Bujak and others (1977) have concluded that the type of organic material (kerogen) present in sediments corresponds to the depositional environments represented by those sediments. For example, amorphous kerogen is common in marine strata, and generally absent from nonmarine strata. Herbaceous kerogen occurs in sediments deposited in all environments, whereas woody kerogen apparently predominates in nearshore marine and nonmarine sediments; coaly kerogen is mostly prevalent in shallow-water deposits.

For the COST No. G-1 well, correlation between kerogen type, abundance, and depositional environment (as indicated by paleontologic and lithologic analyses) is complicated by differences in sampling techniques and data presentation. Nonetheless, the same general trends are apparent for both analyses: amorphous kerogen is a predominant constituent of the kerogen from to a depth of approximately 600-5,400 feet. This is the same interval in which water depths, as indicated by foraminifers, reached their maximums (as much as 600 feet). Below about 5,400 feet, the occurrence of amorphous kerogen becomes sporadic and the other three kerogen types alternate in importance. This correlates closely with a largely terrestrial-origin interpretation for this interval inferred from a general paucity of foraminifers and dinoflagellates. As inferred from the lithologic and paleontologic analyses, numerous marine intercalations are indicated by the kerogen.

The depositional environments inferred from the paleontologic, lithologic and geochemical data are in general agreement. Nevertheless, it is assumed that the interpretations presented here are at best tentative and will be proved correct or incorrect only with further drilling.

SEISMIC VELOCITY AND CORRELATIONS

By Patrick S. Ditty

Velocity data from the Schlumberger Sonic Log and the Uphole Velocity Survey by Seismic Reference Service were compared with interval velocity data derived from USGS Seismic Line No. 77-1. These data were also compared to the lithology log, a porosity log, and to the occurrence of strong reflectors on line 77-1, which was recorded near the COST No. G-1 well. In addition a Change-in-Interval-Velocity (CIV) curve was constructed from the uphole survey interval velocities, and incorporated into the above correlations and comparisons.

Five continuous horizons were picked by Schlee and others (1975) on USGS Seismic Line No. 1 (fig. 15). Four of these horizons were tied to both the G-1 and G-2 wells. The fifth and deepest horizon was not penetrated by either well. The G-1 well was drilled in an area of sparse nonproprietary seismic coverage. However, line 77-1 was shot to tie the well to other seismic data which in turn was tied to the G-2 well (fig. 16). Interval velocities were calculated at shot point 100, about 1000 feet northwest of the G-1 well.

The integrated sonic log was used to plot interval velocities. The same graph was used in plotting interval velocities from the uphole survey and the sonic was corrected to the uphole survey. This plot is shown on figure 17 along with the interval velocities taken from seismic line 77-1 near shotpoint 100. The seismic interval velocities were calculated from the stacking velocities found at the top of the record section. Seven intervals were used, a small number when compared to the number of intervals in the uphole survey. Examination of this figure and figure 18, the time-depth curves for both sets of interval velocities, shows that seismic velocities compare favorably with those from the uphole survey. This indicates that the stacked data are reliable, at least until the depth reaches 12,000-14,000 feet.

A CIV curve was constructed to reduce the cumulative effect of overburden on the appearance of the interval velocity curve. It was plotted

U.S.G.S. MULTICHANNEL LINE 1—OFF GEORGES BANK

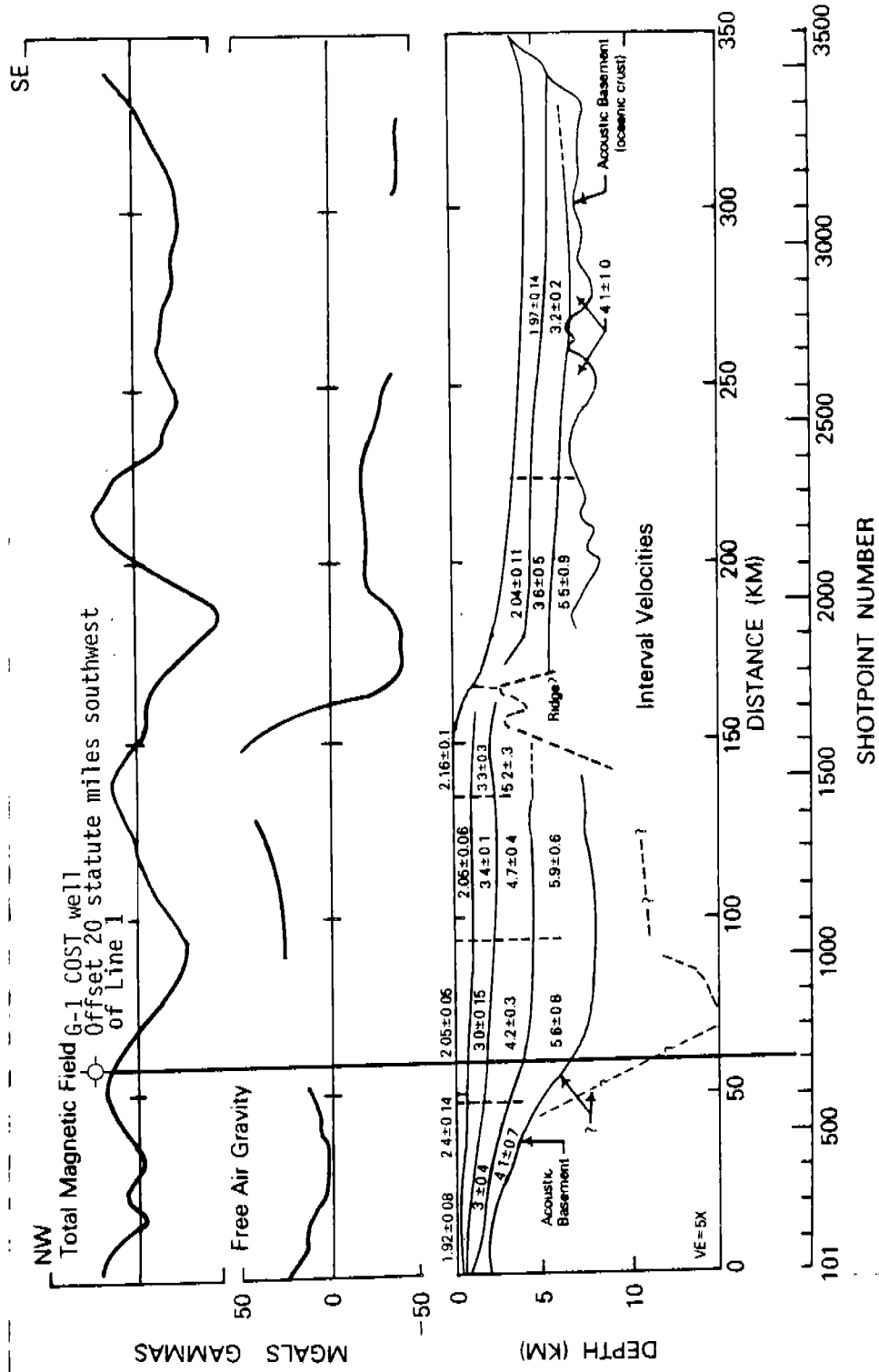

Figure 15. USGS Multichannel Line 1 off Georges Bank, showing relationship of magnetic gravity and seismic data

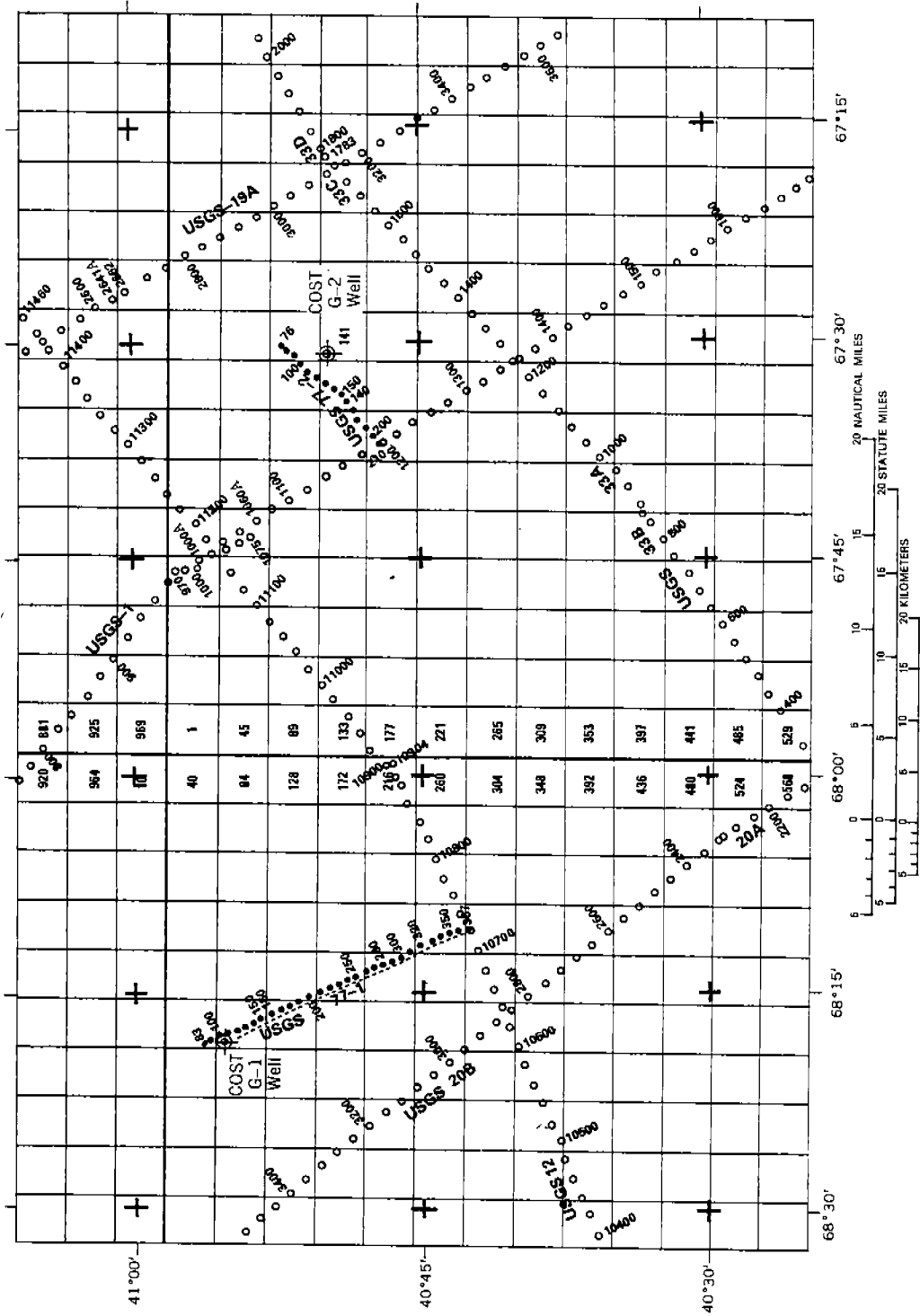

Figure 16. Location map showing COST No. G-1 well and its relation to seismic coverage

from the midpoint of one interval to the midpoint of the next. The result is shown in figure 19, which compares the plot to a detailed lithologic log and to a drilling porosity log (plotted by The Analysts, Inc.). The CIV does not indicate actual velocity, but does show the change in interval velocity from one interval to the next. The only time an actual decrease in velocity is indicated is when the curve is placed to the left of the zero line. A relatively large increase in velocity followed by a less drastic increase would be represented by a large deflection to the right, followed by a deflection to the left. However, this deflection to the left would still be to the right of the zero line.

An examination of figure 19 shows a number of features in the CIV which can be correlated with physical events in the COST No. G-1 well. The first of these is that unconsolidated sediments near the surface show little or no increase in interval velocity (V_I) with depth. The predominantly sandstone sequences from 2,500 feet to 2,900 feet show a larger V_I increase than the shaly sequences above and below. Dolomite layers near 3,600 feet and 5,000 feet show corresponding V_I increases. Lignite at 3,900 feet corresponds to a relatively low V_I increase and is followed by a "surge" beginning in the sandy section at 4,000-4,300 feet. The lignite at 4,600 feet would be expected to produce a slower V_I and therefore a decrease in CIV, however the reverse is the case. This may be explained by a general decrease in drilling porosity. Examination of the well cuttings indicated poor porosity of the rocks both above and below the lignite, possibly yielding an increase in velocity over that interval. The section from about 5,300-5,600 feet, an alternating sand-shale sequence, is characterized by a nearly constant CIV close to the zero line. From there to roughly 6,200 feet, the section is sandier with a corresponding right-deflection in CIV. This trend continues until the limestone section begins at 10,000 feet, with the carbonate layers producing large deflections to the right (large increases in V_I). From 10,000 feet to the bottom of the well, the dolomite-anhydrite sequences produce the largest deflections to the right, with corresponding deflections to the left in the noncarbonate

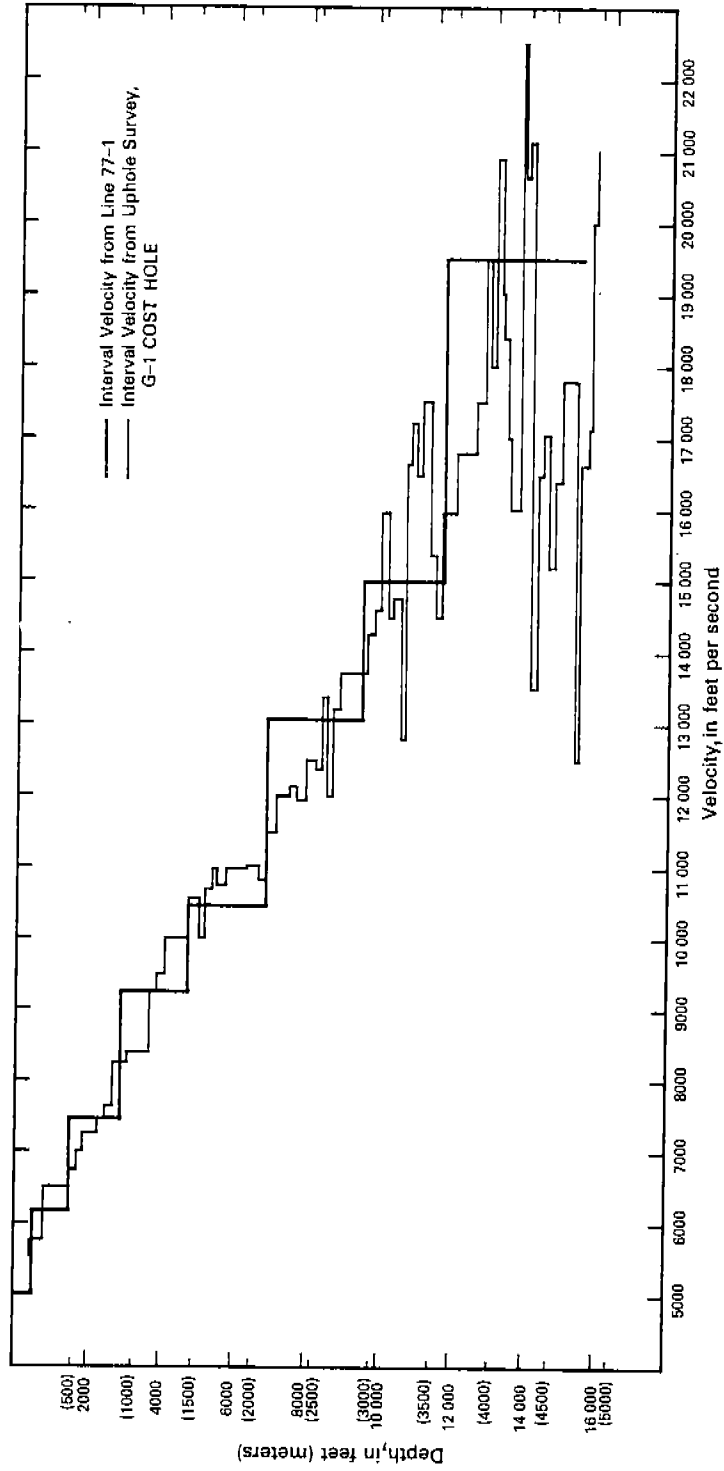

Figure 17. Comparison of interval velocities taken from Uphole Survey at COST No. G-1 well and from seismic line USGS 77-1

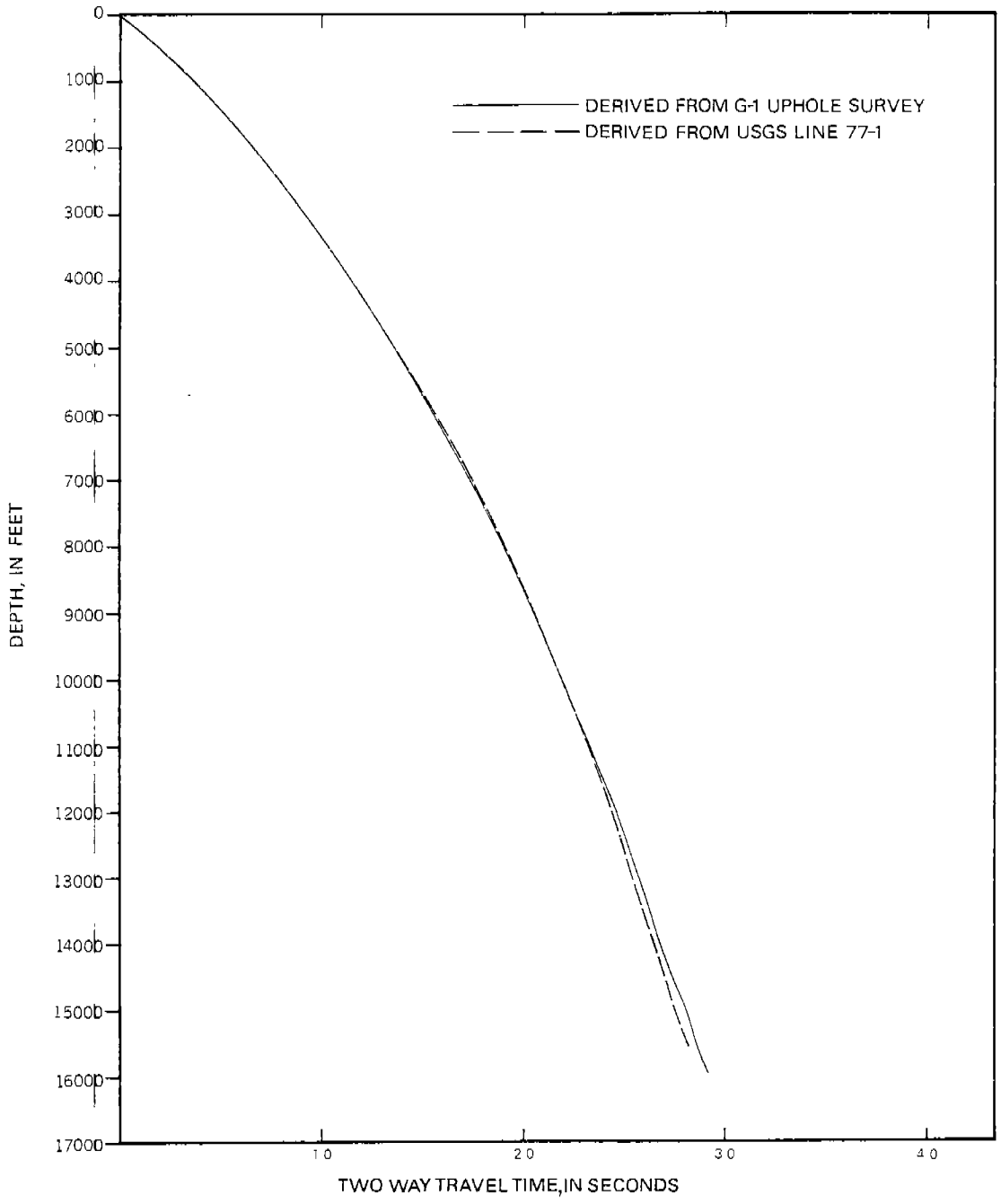

Figure 18. Time-depth curves constructed from COST No. G-1 well Uphole Survey and from seismic line USGS 77-1

sections and also in the more porous limestones and dolomites. In the last 400 feet of the well, the dolomites and sand-shale sequences are metamorphosed, yielding large increases in V_I .

Plate 2 in the rear pocket of this report is a portion of USGS Seismic Line No. 77-1, which shows the seismic events and their relationship to the lithologic changes in G-1 well. Table 4 shows the times of several strong events and their depths in the well. These depths are also plotted on figure 21 next to the lithologic log. It can be seen that these events correspond most closely to the bases of shales, or tops of sandier sequences in the shallower parts of the well. In the deeper, carbonate-dominated section, this same phenomenon occurs, as the event at 2.36 seconds corresponds to a limestone-sandstone interface at 11,500 feet, and the event at 2.67 seconds corresponds to a dolomite-sandstone interface at 14,100 feet. The event at 2.525 seconds and 12,800 feet depth, lies in the middle of an alternating dolomite-anhydrite sequence and appears to be the result of a lithology-related velocity boundary, as indicated by the CIV. Deflections in the CIV curve also correlate well with the presence of seismic events on the record section.

The velocity variations determined here appear to correlate well with the lithologic and porosity changes occurring in the G-1 well, as do the the strongest seismic events. This would indicate that, along with data from the COST No. G-2 well and other seismic data in the area, a cross section could be constructed between the two wells showing the lithologic differences from one to the other. The determinations used in this report could possibly be used to indicate some lateral lithological changes as well.

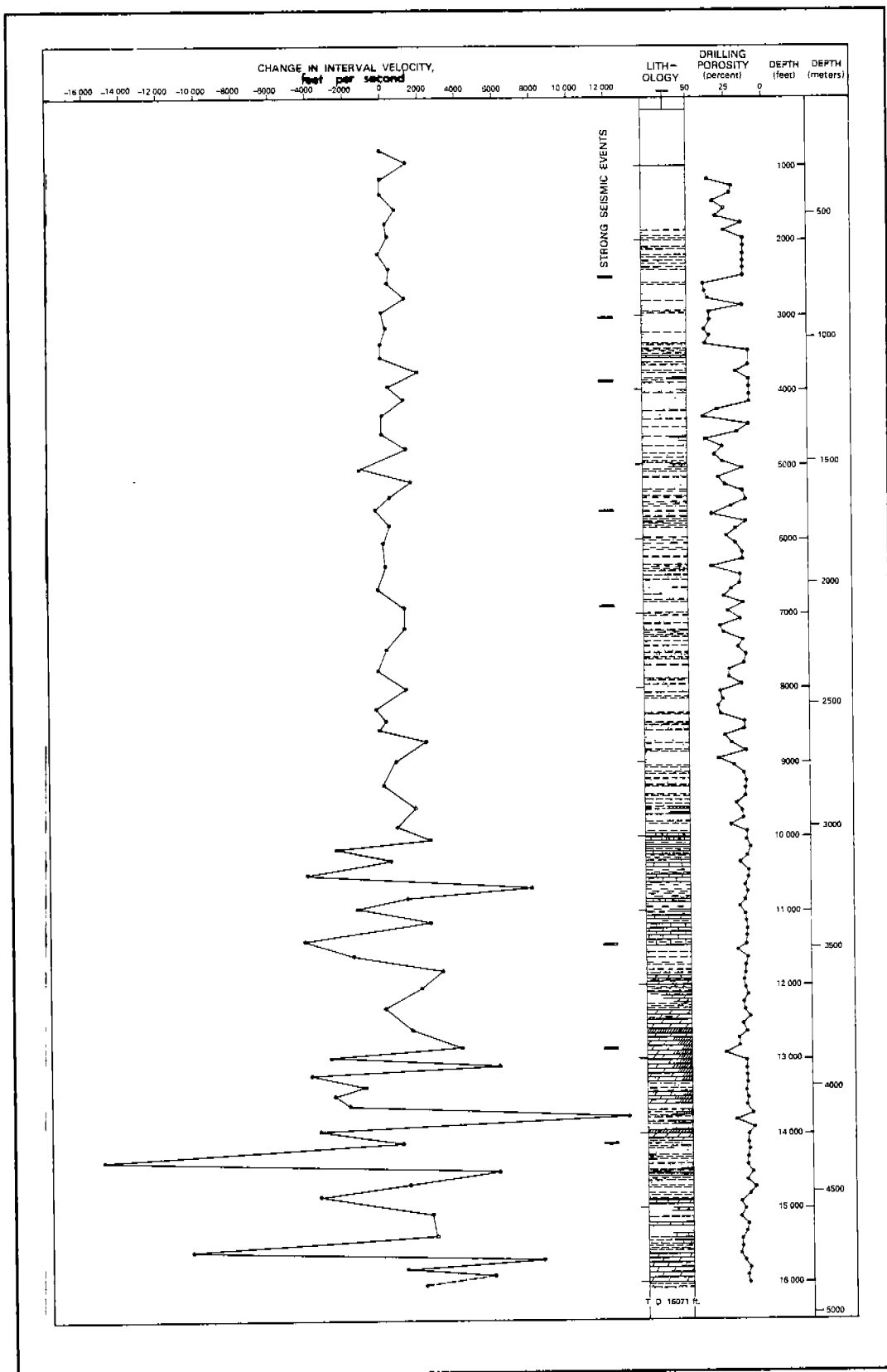

Figure 19. Composite plot showing CIV, lithology, drilling porosity, and depth for the COST No. G-1 well

Table 4. Arrvival times of seismic events and their corresponding depths in the COST No. G-1 well.

Two-way Time (Seconds)	Subsea Depth (Feet)
.775	2,441
.915	2,995
1.110	3,827
1.455	5,583
1.690	6,871
2.360	11,404
2.525	12,826
2.670	14,109

INTERPRETATION OF GEOPHYSICAL LOGS

By Stephen E. Prensky

A complete suite of wireline geophysical ("electric") logs (listed below) was run in the COST No. G-1 well by Schlumberger Ltd. to provide data for petrophysical (formation porosity, permeability, lithology, fluid content) analysis and structural dip determination. These data are available in both analog (diaz prints) format and digital format (magnetic tape). The log suite consists of:

<u>Log</u>	<u>Depth (ft) below KB</u>
Dual-Induction Laterolog (DIL)	971 - 16,038
Compensated Neutron-Formation Density (CNL-FDC)	971 - 16,042
Compensated Formation Density (FDC) (Gamma-Gamma)	971 - 16,042
Borehole-Compensated Sonic (BHC)	4,065 - 16,044
Long-Spaced Sonic (LSS)	4,065 - 16,040
Proximity Log-Microlog (PML)	971 - 16,043
High-Resolution Dipmeter (HRD)	971 - 16,040
Temperature Log	971 - 16,043

A lithology (mud) log, drilling pressure log and pressure analysis log were run on the well. This chapter presents preliminary results of COST No. G-1 porosity data. Porosity values were computed on 1-foot increments from data on the CNL-FDC and BHC logs.

Hole Condition

Log quality is good and all log traces are depth adjusted to the DIL log. Hole washouts, indicated by the caliper on the CNL-GDC tool, complicate log evaluation of the well. Above 5,000 feet severe hole washouts occur primarily in unconsolidated sands. Below 5,000 feet, washouts generally occur in the shaly intervals. The very low bulk density values above 4,000 feet are due to a high water content in the unconsolidated sands.

During examination of the BHC and CNL-FDC log data it was observed that large fluctuations in tool response, particularly the CNL-FDC, occur at depths where hole size exceeds the bit size by more than 2.5 inches. Also at these depths the density correction curve (DRHO), usually a good indicator of the reliability of tool response, exceeds 0.1. When DRHO is greater than 0.1, possibly due to a thick mudcake or improper tool position against the wall, bulk density values may be unreliable. Consequently porosity data were computed for both conditions, i.e. using all available data, and using data at depths where hole size is less than the bit size plus 2.5 inches.

Log Analysis

The COST No. G-1 well can be divided into an upper (above 9,950 feet) clastic interval and a lower (9,950-16,063 feet) carbonate interval. These two intervals were further subdivided on the basis of dominant lithology and drilling conditions (mud weight and bit size) for individual analysis.

The matrix density values used in calculating porosity from the FDC bulk density data are summarized in table 5. When possible, the values were obtained by averaging the grain densities obtained from analyses of the conventional cores. For the upper clastic interval a matrix density of 2.65 gm/cc was used. A second porosity calculation using a matrix density of 2.68 gm/cc was made because of the calcareous nature of some of the sands. Selection of a value for matrix density in the lower carbonate zones was more complex. In this interval the dominant lithology is usually not "clean" (pure) limestone, dolomite, or anhydrite; rather there is a gradational change from one to another and within one type the proportions change. Consequently, use of the standard matrix density values of 2.71 gm/cc for limestone or 2.87 gm/cc for dolomite could give porosities which are misleading and/or unrepresentative. Using core data, where available, as a guide, a value for matrix density was selected and a porosity value calculated. For comparison, two other porosity values

were calculated using standard matrix densities for limestone and dolomite.

Matrix travel times, in microseconds/foot, used in the calculation of porosity from the BHC tool are: 55.5 in the clastics above 9,940 feet, 52.5 for the lower interval clastics; 47.6 in limestone intervals; 43.5 for dolomite. Sonic porosities were corrected for undercompaction (where necessary) using a compaction factor determined from the travel time in shale intervals. Average porosities determined using each tool (FDC, CNL and BHC) for the intervals examined are summarized in table 6. Effective porosity for each depth was calculated and these data are summarized in table 7.

Effective porosity was obtained by subtracting the volume of shale (Vsh) from the weighted average porosity value obtained from corrected CNL and FDC porosities. This procedure used shale and "clean" matrix values determined from either the gamma-ray log trace or cross-plots. The problem in determining Vsh was in selection of end-point values for "clean" sand or "clean" matrix (in the case of carbonates) and "clean" shale. Values selected in the upper clastic interval (above 9,950 feet) are probably reliable; however, in the lower clastics (below 9,950 feet) and carbonates the values chosen are approximate because of the lack of a shale unit of sufficient thickness to provide reliable tool response and because of the gradational nature of the carbonate matrix and cement. Comparison of porosities obtained from conventional core analysis in table 5 with the corresponding values in table 7 illustrates the problem in selecting these "clean" values. In the upper clastic interval the values are very close and in the lower intervals (e.g. 13,929-13,944 feet) average core porosity of 6.2 percent is greater than the corresponding effective porosity of 1.4 percent.

Table 7 shows summations of the number of feet with an effective porosity above the indicated porosity limit with a Vsh of less than 50 percent. The values of effective porosity were calculated using the matrix

density shown in column 3. On a porosity basis, reservoir potential is very good in the clastics (971-9,940 feet), good in the clastic/carbonate interval (9,941-11,450 feet), good to fair in the interval from 11,451 to 12,360 feet, and poor from 12,361 to 15,980 feet.

Table 5: Summary of grain density and porosity values for cored intervals

Core Type	Core No.	Cored Interval (feet below KB)	Cut (ft)	Recovery (ft)	Lithology (Core Description)	Average grain density (gmc/cc)	Average porosity (percent)	Number of Samples
SWC	-	993 - 5,200	-	-	Sand, mudstone	2.62	26.4	52
CON	1	5,120 - 5,142	22	0	-	-	-	-
CON	2	5,469 - 5,489	20	12	Ss, mudstone	2.66	29.5	7
SWC	-	5,285 - 7,928	-	-	Ss, sh	2.62	24.5	69
CON	3	9,980 - 10,006	26	23	ls w/ss stringers	2.68	2.2	13
SWC	-	10,459	-	-	Ss, calcareous	2.65	2.5	1
SWC	-	10,925	-	-	Dol, anhydrite	2.62	16.5	1
SWC	-	11,498 - 11,761	-	-	Ss, dolomitic	2.62	16.7	3
CON	4	12,897 - 12,947	50	45	Anhy w/dol	-	-	No Analysis
SWC	-	13,377	-	-	Ss, dolomitic	2.72	4.6	1
CON	5	13,929 - 13,944	15	11.6	Ss w/conglomerate	2.71	6.2	4
SWC	-	14,220 - 15,065	-	-	Ss, dolomitic	2.58	19.9	1
SWC	-	15,580	-	-	Metamorphics	2.56	17.5	1
CON	6	16,051 - 16,071	20	12	Phyllite	-	-	No Analysis

Key
 SWC - Sidewall cores
 CON - Conventional (diamond) cores
 ss - sandstone
 sh - shale
 mudst - mudstone
 ls - limestone
 dol - dolomite
 anhy - anhydrite
 uncon - unconsolidated

Table 6: Interval porosity averages (in percent)

Interval (feet)	Lithology	gm/cc	2.65		2.68		2.71		2.80		2.87		Neutron		Sonic		Sonic Matrix Microsec/ft	
			ALL	2.5	ALL	2.5	ALL	2.5	ALL	2.5	ALL	2.5	ALL	2.5	ALL	2.5		
973- 4,051	Uncon Ss, mudst		35.2	26.9	36.4	28.2	-	-	-	-	-	-	-	49.8	47.7	-	-	55.5
4,067- 5,200	Ss, sh		25.0	23.7	26.4	25.1	-	-	-	-	-	-	-	40.1	39.6	31.3	31.1	55.5
5,201- 9,940	Ss, sh		17.2	17.2	18.7	18.6	-	-	-	-	-	-	-	32.2	32.2	21.3	21.2	55.5
9,941-11,450	ls, sh w/ss		12.4	3.2	13.1	3.6	15.1	8.2	-	-	-	-	-	15.9	10.6	12.1	9.3	47.6
11,451-11,891	Ss, sh w/lis		12.1	6.6	13.6	8.2	-	-	-	-	-	-	-	11.5	8.6	8.5	7.1	52.5
11,892-11,970	Do1, sh		-	-	-	-	12.7	4.1	17.0	8.9	20.1	12.3	13.7	9.0	11.7	9.6	9.6	43.5
11,971-12,360	Ss, sh		7.8	1.7	10.1	4.8	-	-	-	-	-	-	-	13.9	10.7	7.5	5.9	52.5
12,361-13,300	Do1, anhy, sh		-0.4	-0.4	2.0	2.0	-3.2	-6.2	1.9	-0.9	5.6	2.9	5.1	3.9	7.4	6.6	6.6	43.5
13,301-13,420	Ss, sh		-	-	-	-	-	-	-	-	-	-	-	11.0	11.0	11.6	11.6	52.5
13,421-13,610	Do1, sh		-	-	-	-	-1.9	-4.1	3.2	1.1	6.9	4.8	6.3	5.0	7.1	7.6	7.6	43.5
13,611-13,945	Ss, sh w/do1		-2.4	-2.4	1.4	1.2	-	-	-	-	-	-	9.0	9.1	4.1	4.0	4.0	52.5
13,946-14,130	Do1, sh		-	-	-	-	-3.4	-2.8	1.7	2.3	5.4	5.9	6.8	7.7	8.3	9.9	9.9	43.5
14,131-15,560	Ss, sh w/anhy		-2.7	-3.3	0.7	0.3	-	-	0.9	0.8	4.6	4.5	9.7	9.8	5.8	5.6	5.6	52.5
15,561-15,980	Do1, sh		-	-	-	-	-4.3	-4.4	0.9	0.8	4.6	4.5	9.7	9.8	7.6	7.6	7.6	43.5

ALL - Average for all values within an interval

2.5 - Average of values only at depths where hole size less than bit size + 2.5 inches

Table 7: Summary of effective porosity and porosity-feet

Interval (feet)	Lithology	Matrix Density gm/cc	Effective Porosity %		Porosity-Feet										
			a	b	>15%		>10%		>8%		>6%		>3%		
					a	b	a	b	a	b	a	b	a	b	
973 - 4,051	Sand, mudstone	2.65	22.0	24.6	1857	630	1908	681	-	-	-	1930	703	-	-
*4,067 - 5,200	Ss, sh	2.65	19.1	24.2	773	590	830	638	-	-	-	854	660	-	-
5,201 - 9,940	Ss, sh	2.65	16.2	17.2	2290	2167	2804	2666	-	-	-	3208	3051	-	-
9,941 - 11,450	Ls, sh w/ss	2.71	6.4	6.4	-	-	-	-	397	66	518	108	47	740	191
11,451 - 11,891	Ss, sh w/lis	2.65	9.2	6.3	95	3	166	19	-	-	254	47	-	-	-
11,892 - 11,970	Dol, sh	2.87	8.8	9.1	-	-	-	-	29	8	38	14	50	21	-
11,971 - 12,360	Ss, sh	2.68	8.2	5.3	83	10	161	43	-	-	213	70	-	-	-
12,361 - 13,300	Dol, anhy, sh	2.87	2.4	5.2	-	-	-	-	90	53	117	74	172	123	-
13,301 - 13,420	Ss, sh	2.68	1.6	2.5	0	0	0	0	-	-	7	7	-	-	-
13,421 - 13,610	Dol, sh	2.87	2.5	2.6	-	-	-	-	9	0	24	1	61	12	-
13,611 - 13,945	Ss, sh w/dol	2.68	1.4	1.8	0	0	0	0	-	-	8	6	-	-	-
13,946 - 14,130	Dol, sh	2.87	2.6	4.0	-	-	-	-	8	4	20	12	73	40	-
14,131 - 15,560	Ss, sh w/anhy	2.68	1.7	2.6	0	0	32	28	-	-	58	38	-	-	-
15,561 - 15,980	Dol, sh	2.87	3.2	4.9	-	-	-	-	25	23	70	68	226	224	-

Key

a - All samples where Vsh is less than 50 percent

b - Samples where hole size is less than bit size +2.5 inches and Vsh is less than 50 percent

* 4,051 - 4,066 data not recorded

Dipmeter Interpretation

A four-arm, High-Resolution Dipmeter (HRD) was run in the COST No. G-1 well between 971 and 16,040 feet, and the computed results were recorded on a Dipmeter Arrow Plot. Although dip readings in many intervals are highly variable, the beds down to 15,050 feet appear to be dominantly horizontal or dipping gently (1 to 4 degrees) to the south and east. Some east-northeast dip directions were recorded between 14,000 and 15,050 feet. Between 15,050 and 15,600 feet, in a conglomeratic section, dominantly northwest dips of 10 to 30 degrees were recorded. Because seismic reflection records do not show significant dip in this interval, the relatively steep northwest dips recorded by the dipmeter are interpreted to represent crossbedding.

Below 15,600 feet, to the deepest plotted dips at 16,030 feet, south-east dips of 18 to 40 degrees and more were recorded in Paleozoic (?) dolomite and phyllite. In confirmation of these steep dips, a core recovered from the depth of 16,051 to 16,071 feet indicated apparent dips of 25 to 30 degrees. After removing the effect of deviation of the drill hole from the vertical, true dips in the cored interval are estimated to be 35 to 40 degrees.

Dipmeter data are summarized below:

<u>Depth (ft)</u>	<u>Lithology</u>	<u>Dip (degrees)</u>	<u>Direction</u>
971 - 9,950	Sandstone, shale	1-4	S - E
9,950 - 14,030	Limestone, dolomite, sandstone, anhydrite	1-4	S - E
14,030 - 15,050	Dolomite, shale, sandstone, anhydrite	2-4	E
15,050 - 15,600	Sandstone, shale	10-30	NW
15,600 - 15,850	Dolomite, shale	18-40	SE
15,850 - TD	Phyllite	-	-

FLUID ANALYSIS AND PRESSURE DATA

By Lucille Tamm

Both formation fluid composition and pressure data were measured in the COST No. G-1 well using wireline downhole formation tests (FT). Small quantities of fluid from the intervals of formations being tested were analyzed for their organic, ion, and dissolved solids content by Amoco Production Company (written communication, 1976). Samples were taken at 6,917, 7,907, 9,362, 9,868, 11,498 and 11,634 feet.

A total of 29 formation tests were attempted. Table 8 summarizes the pressure data for tests between 4,780 and 9,868 feet. These tests recovered only mud filtrate. Consequently, the analysis does not reflect the composition of the formation fluid.

Tests 2-4, 10-13, and 14-15 each had to be reset at slightly different depths before a zone having moderate permeability as indicated by a higher sampling pressure could be found and fluid samples taken. This indicates that even in zones indicated on the electric logs as being porous, there may be thin, tight streaks.

After reaching total depth a second series of formation tests were attempted. Severe washout problems prevented all but two of the tests from providing any data. Table 9 summarizes the pressure data for the second series of tests.

Table 8.--Pressure data for depths 4,780 to 9,868 feet

Test No.	Depth (feet)	Initial shut-in (psi)	Sampling (psi)	Final shut-in (psi)	Hydrostatic (psi)
1	9868	4405	1426	4372	5124
	9868	4405	1650	4372	5124
	9868	4405	1610	4350	5124
2-4	9363	4098	24	NM	4846
	9363	4098	9	NM	4846
	9362	4098	3493	4090	4849
5-7	8867	3881	11	NM	4610
	8867	3811	9	NM	4610
	8860	3878	20	NM	
	8860	3878	19	NM	
	8861	3880	14	NM	
	8861	3880	18	NM	
8-9	8600	3763	13	NM	4462
	8600	3763	15	NM	
	8590	3760	15	NM	4462
	8590	3760	9	NM	
10-13	7928	3458	13	NM	4125
	7928	3458	106	3456	
	7928	3456	169	3456	4114
	7928	3456	106	3454	4114
	7907	3448	3337	3442	4095
14-15	6914	3009	18	NM	3590
	6914	3009	15	NM	NM
	6914*	NM	17	NM	NM
	6914*	NM8	2799	3007	3593
16-19	5601	2404	almost zero	NM	2904
	5602	2404	almost zero	NM	NM
	5604	2406	19	NM	NM
	5604*	NM	19	NM	NM
	5604*	NM	2	NM	3070
	5908	2544	2	2544	NM
20	4780	23	NM	NM	NM
	4780*	24	NM	NM	2482

*tool retracted slightly

NM - Not measured

Table 9.--Pressure data for depths 10,090 to 16,063 feet

Test No.	Depth (feet)	Initial shut-in (psi)	Sampling (psi)	Final shut-in (psi)	Hydrostatic (psi)
1	14564*	NM	NM	NM	7885
2	14420	6428	150	NM	7800
3	14450*	NM	NM	NM	NM
4	13377*	NM	NM	NM	7236
5	13724	6267	nil	NM	7420
6	13816	400	nil	NM	7485
7	11498	5104	5300	NM	NM
8	10925*	NM	NM	NM	NM
9	11634	5069	5013	5069	6294

*Tests which were not completed because of washout zone
 NM - Not measured

GEOHERMAL GRADIENT

By Dana S. Jackson and Bruce A. Heise

The thermal gradient (TG) for the COST No. G-1 well was determined using a unique mathematical approach where the well data were used to approximate a true lithologic temperature (TLT) at various depths within the well. This method differs from the usual treatment of temperature data, such as straight linear regression techniques (see, for example, Robbins and Rhodehamel, 1976), in that all the temperatures for each depth were extrapolated to a standard time of 25 hours after the end of circulation.

Initially, the temperature data were recorded for each logging run and plotted according to time and depth (fig. 20). After noting the characteristics of the heat transfer between the surrounding lithologies and the drilling fluid, a logarithmic regression was applied to the data to calculate a TLT for each depth. Based on the thermal properties of drilling fluids, these corrected data yielded TLT's accurate within 90 - 95 percent (Baroid Division, NL Industries Inc., written commun., 1979).

After a TLT was calculated for each depth, a plot of temperature versus depth was made (fig. 20). From the following TLT's, a linear regression was used to estimate the thermal gradient:

TLT (est. for 25 hrs.)	Average Depth (ft.)
112.00°F	4,059
166.32°F	10,102
227.85°F	13,654
247.35°F	16,040

Using the above methods the thermal gradient for the G-1 well was calculated to be 1.17°F per 100 feet. This value is only slightly lower than that calculated by applying a linear regression to the temperature log of the well, which yielded a thermal gradient of 1.26°F per 100 feet. The

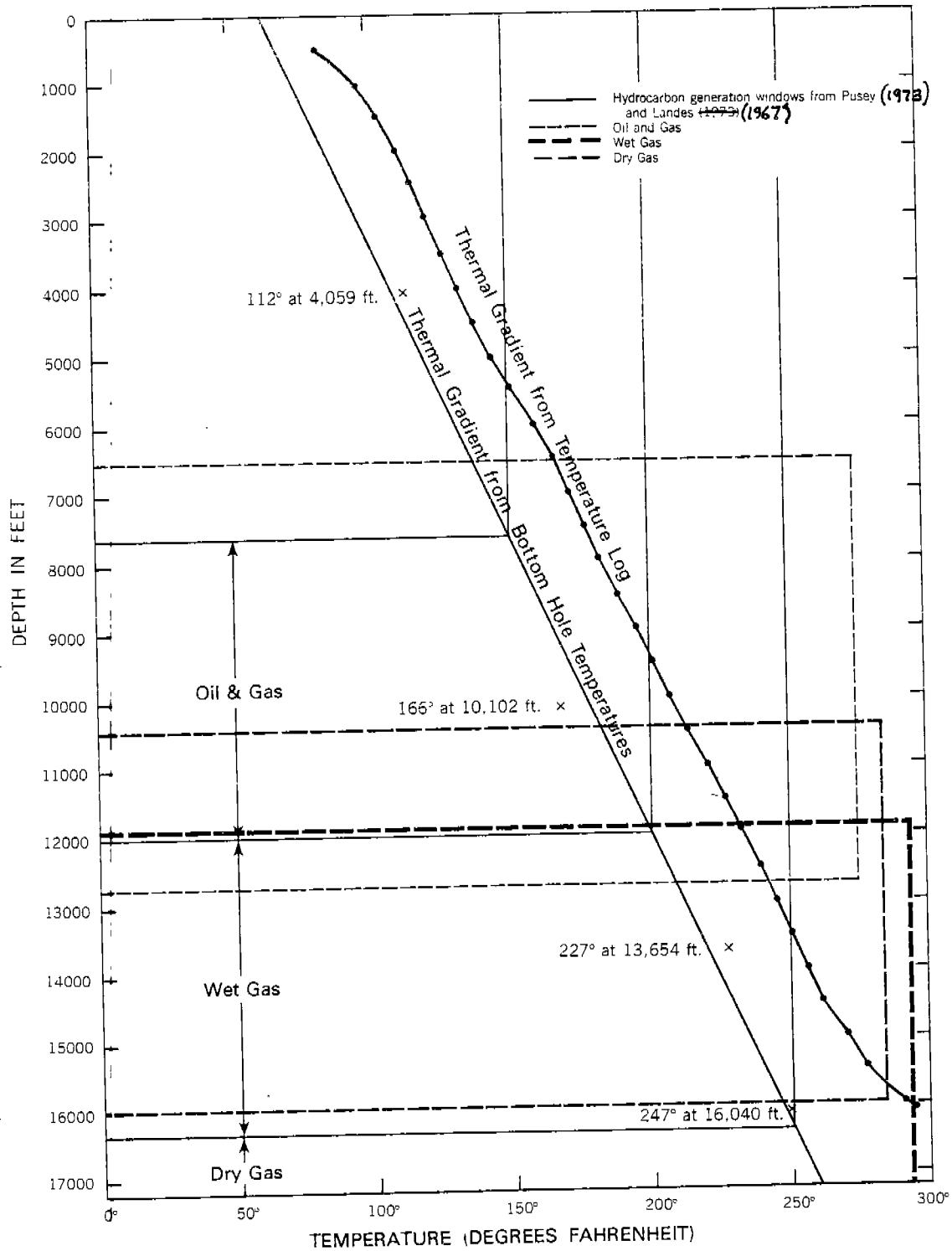

Figure 20. Thermal gradient for the COST No. G-1 well with a comparison of organic and temperature - determined hydrocarbon generation windows

The thermal gradients of other COST wells were similarly calculated (table 10).

Although present-day TG cannot be used to evaluate potential oil and gas source rocks, it can be used to estimate the hydrocarbon state at any depth by projecting it onto hydrocarbon generation windows described by Landes (1967) and Pusey (1973) (fig. 1). The limiting isotherm for generating hydrocarbons is 150° F, reached in the G-1 well at 8,000 feet. The oil and gas floor occurs at 12,125 feet, and the wet gas floor at 16,250 feet, 171 feet below the total depth of the well. These values compare favorably with those obtained from vitrinite reflectance, which had the oil floor at 12,800 feet, and a wet gas floor at 15,800 feet. The dry gas floor would not be reached until below 20,000 feet.

Table 10.--Comparison of offshore geothermal gradients.

Area	Well No.	Gradients		Reference
		°F/100 ft	°C/km	
Scotian Shelf		(1.2)*	(21.9)	Robbins and Rhodehamal (1976)
Texas Gulf Coast		(2.6)*	(47.4)	Robbins and Rhodehamal (1976)
Baltimore Canyon	B-2	1.3(1.3)**	23.7(23.7)	Jackson, Dana, unpublished (1979)
Baltimore Canyon	B-3	1.2	21.9	" " " "
Southeast Georgia Embayment	GE-1	0.9(0.9)	16.4(16.4)	" " " "
Georges Bank	G-1	1.2(1.3)	21.9(23.7)	this paper

*TG values obtained from bottom hole temperatures of electric logs.

**TG values obtained by applying a linear regression to TLT are given initially (where available) and are followed in parentheses by values taken from the temperature log.

GEOCHEMICAL ANALYSIS

By Michael A. Smith and Donnie R. Shaw

Source Rock Potential

The potential petroleum generation of the stratigraphic section in the COST No. G-1 well was evaluated on the basis of geochemical data acquired from the detailed analysis of well cuttings. The organic richness, the light- and gasoline-range hydrocarbon content and composition, and the amount and composition of solvent-extractable organic matter and hydrocarbons, as well as the type of organic matter and the thermal maturity, were determined by GeoChem Laboratories, Inc. (1976). Sample splits of some of the cuttings and processed material were also sent to three participating companies for associated geochemical studies. The values of some principal geochemical parameters are listed in table 11 and shown in figures 21, 22, and 24.

Measurements of the organic carbon content provide a basic index of organic richness for potential source rocks. Minimum values of 0.5 to 0.6 percent in shales and 0.2 percent in limestones are needed before any significant amount of petroleum generation can occur. Obviously (table 5, fig. 21), except for a few scattered high values at other depths, the section between 4,600 and 6,200 feet represents the only potential source for oil and gas. This section was designated zone B by GeoChem (1976). Their zones and subzones for the G-1 well are marked on plate 1 and figures 21, 24, and 26. The total organic carbon was measured for 63 picked-lithology samples used for C₄ to C₇ gasoline-range analysis and for 54 cuttings samples chosen for C₁₅₊ extraction and analysis. Average organic carbon content for the analyzed samples is 0.14 percent for zone A, 1.53 percent for zone B, and 0.26 percent for zone C.

The light hydrocarbon (C₁-C₄) composition provides another measure of source rock richness and state of maturation. Well cuttings collected at 60-foot intervals and air space in the storage cans were initially analyzed for their C₁ through C₇ hydrocarbon content. Zone B with its higher organic

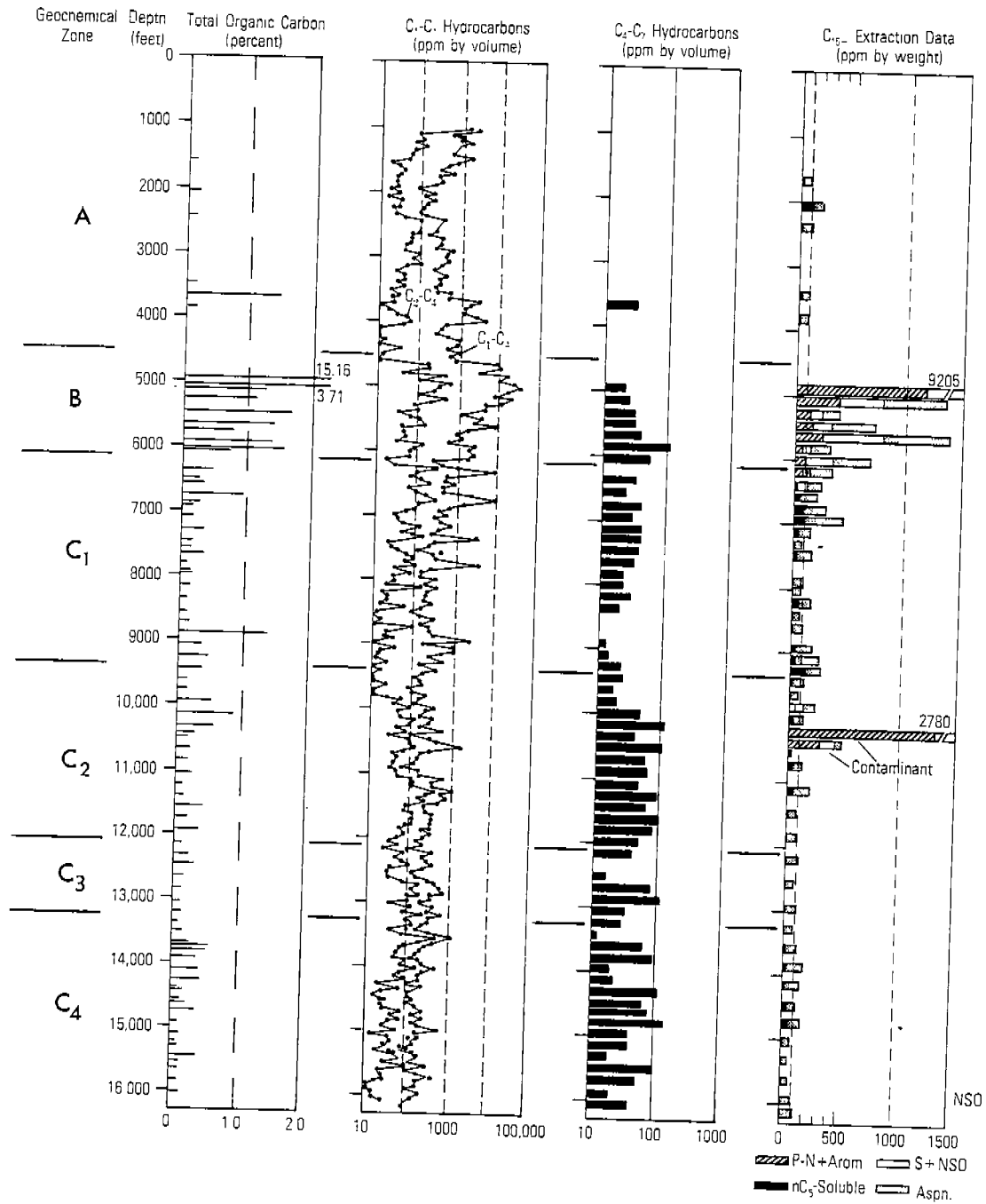

Figure 21. Measurements of the organic richness of sediments in the COST No. G-1 well

carbon content also contains the greatest concentration of C₁ through C₄ hydrocarbons. Most samples from zone B contain more than 1,000 ppm light hydrocarbons; some samples from the upper half of this zone contain more than 10,000 ppm. These high values reflect the presence of some biogenic methane, although the wet gas components, C₂ through C₄, in the light hydrocarbon fraction also increase in zone B to an average of 145 ppm. The C₄ through C₇ gasoline-range hydrocarbon concentrations (table 5 and fig. 21) increase in zone B, but are insignificant because these sediments are immature and have not yet generated any oil or gas. The C₄ through C₇ content increases slightly below 10,000 feet indicating the greater thermal maturity of a nonsource section.

Solvent-extractable organic matter from 54 cuttings samples was separated into an asphaltene and a pentane-soluble fraction. Adsorption chromatography was used to separate the pentane-soluble components into C₁₅₊ paraffin-naphthene hydrocarbons, C₁₅₊ aromatic hydrocarbons, and a C₁₅₊ nitrogen-sulfur-oxygen containing fraction. The heavy hydrocarbon concentrations are listed in table 11, but the quantities recovered were too small for detailed analysis of most of the extracted material except for zone B. Extraction data for all samples are shown in figure 21; the C₁₅₊ material is very sparse except in zone B. The prospective nature of zone B for oil and gas generation is again shown by its mean values of 151 ppm C₁₅₊ total hydrocarbon and 736 ppm C₁₅₊ bitumen. The high values seen in two samples from zone C₂, however, probably result from gilsonite and lignite contamination that originated in mud additives used to free a jammed core barrel during the cutting of core 3 from 9,980 to 10,006 feet.

Hydrocarbon Source Type

The type of hydrocarbon produced from organic-rich source beds depends on the type of kerogen found in the rocks and on its time-temperature history. Aquatic and unstructured organic material is

generally oil prone, whereas terrestrial and structured kerogen tends to produce gas. The relative abundance of the four main kerogen types is shown in figure 22. Amorphous and herbaceous kerogen derived from slightly altered plant detritus is predominant throughout most of zones A and B. In zone C the relative quantity of amorphous kerogen decreases as woody and coaly types become more widespread, and no recognizable algal material was found below 8,560 feet. Therefore, kerogens that can produce both gas and oil are present throughout the stratigraphic section although gas becomes increasingly likely at greater depths.

Elemental analysis of the C, H, O, and N content of kerogen can qualitatively indicate the expected character of generated hydrocarbons and their level of thermal alteration (LaPlante, 1974). Amoco Production Company (written commun., 1976) analyzed cuttings from 48 depth intervals for these elements and their calculated atomic H/C ratios are shown in table 5 and figure 22. Although the most oil productive kerogens have H/C values greater than 1.0, source beds with H/C ratios between 0.75 and 1.0 can produce both gas and oil. The H/C data therefore support the interpretation based on visual kerogen analysis that all types of hydrocarbons could be generated throughout most of zone B, at least in the interval above 5,700 feet. Part of the variation in measured elemental concentrations throughout the well may be the result of recycled kerogen, caving, or partial oxidation, and some hydrogen loss has also occurred in the more mature samples below 12,000 feet.

Another method that indicates, indirectly, the type of organic matter and its depositional environment is comparison of the stable carbon isotope composition of components in the solvent-extractable fraction. Carbon isotopic data were provided by Phillips Petroleum Company (written commun., 1976) for the total extract (pentane-soluble), the saturated hydrocarbon (paraffin-naphthene), and the asphaltene fractions that were processed by GeoChem for 38 cuttings samples. The ratio of the two stable carbon isotopes, C^{12} and C^{13} , is given relative to a standard according

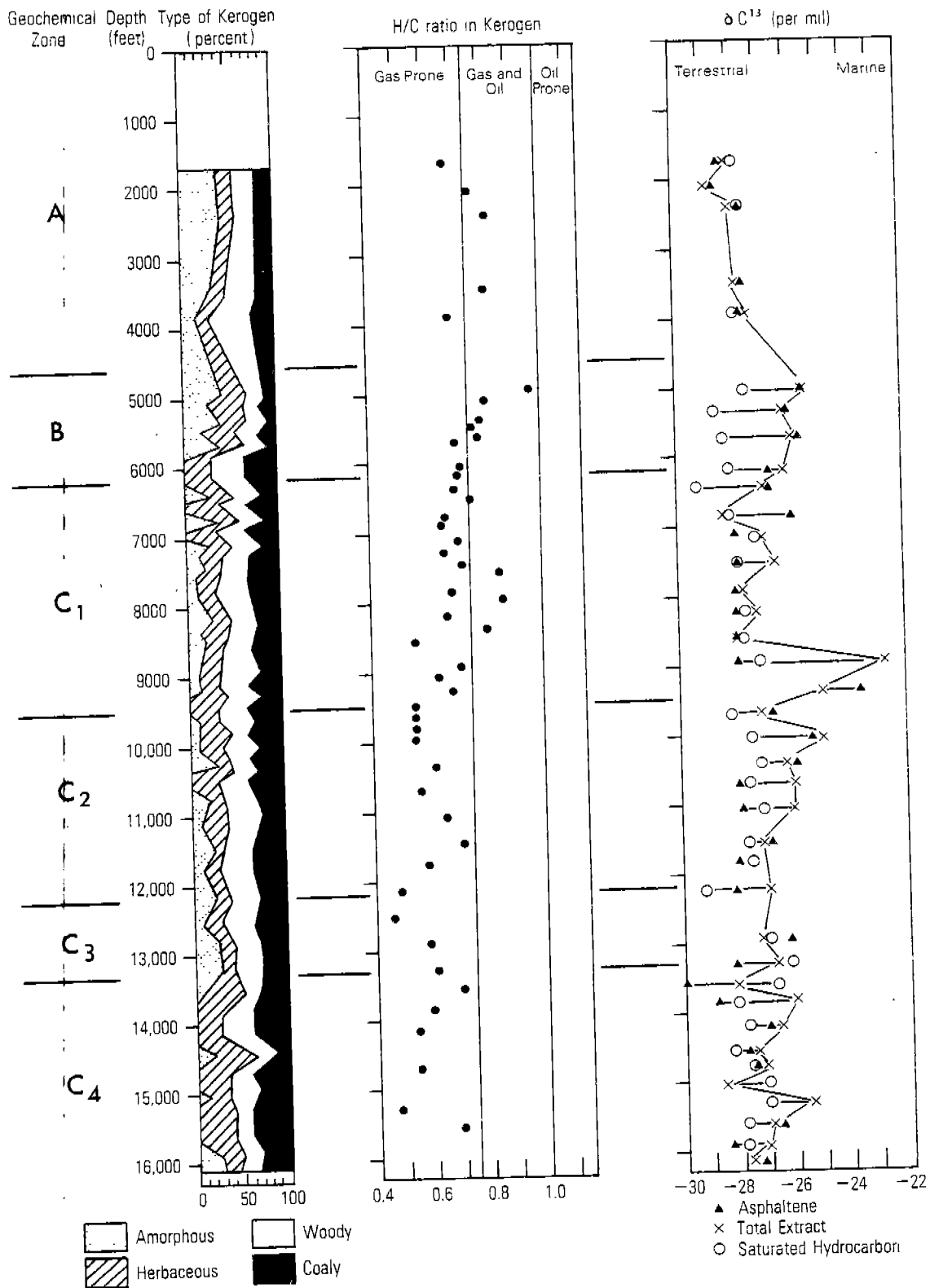

Figure 22. Measurements showing the type of organic matter in the COST No. G-1 well

to the formula:

$$\delta C^{13} \text{ (per mil)} = [(R_s - R_r)/R_r] \times 1,000$$

where $R_s = C^{13}/C^{12}$ ratio in the sample and
 $R_r = C^{13}/C^{12}$ ratio in the reference standard.

The isotopic value of the total extract is somewhat lighter (less C^{13} and more negative numbers) throughout most of zone C than in zone B indicating a more terrestrial and gas-prone source deeper in the well.

Thermal Maturity

Several methods have been devised to measure the level of thermal alteration attained by organic matter in sediments and to determine whether the potential source rocks have been exposed to sufficient temperatures over a long enough period of time to have produced significant amounts of oil and gas. The most widely used techniques for determining the level of maturation are based on the color and reflectivity of organic particles. These characteristics are measured by the thermal alteration index (TAI) and vitrinite reflectance (R_o) and generation from envelopes for oil and gas are given in figure 23 for the major kerogen types.

The color of organic material in sediments--spores, pollen, plant cuticles, resins, and algal bodies--changes with increased temperature from light yellow to black and can be observed through a microscope under transmitted light. Staplin (1969) assigned a numerical index to the colors associated with material of a known degree of thermal alteration as shown in figure 23. Values for this visual index (fig. 24) show an overall increase in maturity with depth. The best zone for oil production with TAI values of 2+ to 3 occurs below 13,800 feet, although early stages of petroleum liquid generation are possible below 9,700 feet. This is considerably deeper than the zone determined for peak oil generation by vitrinite reflectance analysis, a technique which shows the effects of the duration of heating as well as the maximum temperature encountered.

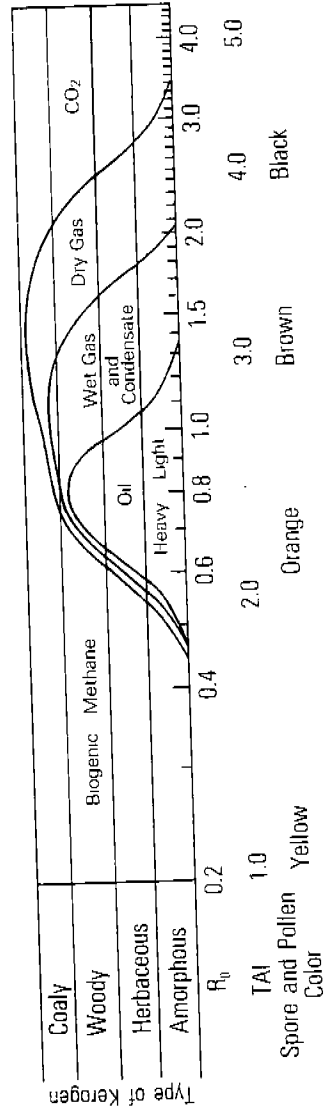

Figure 23. Schematic diagram showing oil and gas generation zones as a function of maturation index and kerogen type

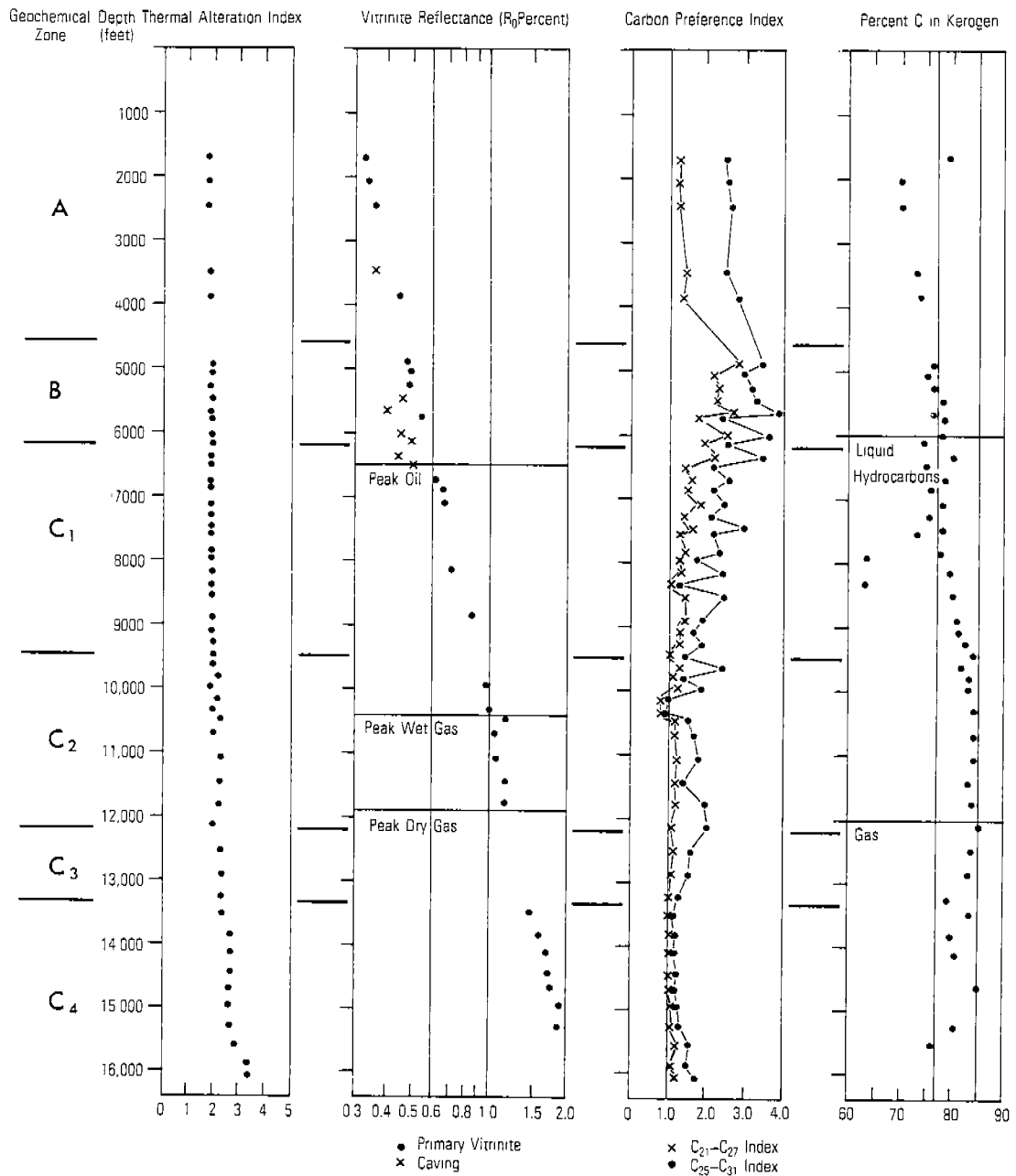

Figure 24. Measurements showing the maturity of organic matter in COST No. G-1 well

The reflectance capability (R_o) of polished vitrinite particles was measured for 46 cuttings samples by the Superior Oil Company (written commun., 1976). The zones of oil, wet gas, and dry gas generation can be delineated by the R_o values shown in figure 25, a technique discussed in detail by Dow (1977). The vitrinite reflectance data provide a maturation profile (fig. 24) based on values for the primary population (table 11). The anomalously low values for 5,500-6,500 feet appear to be caused by caving from an overlying coaly section. Also, the lack of vitrinite with lower values, between 0.2 and 0.3 percent, indicates that about 2,000 feet of Tertiary section has been eroded away at some point. Recycled vitrinite of a higher rank of 5,000-13,000 feet depth forms a secondary population, one with an earlier thermal history, with little hydrocarbon-generating potential. An R_o value of 0.6 percent occurs at about 6,500 feet and significant oil generation could have occurred below this depth. The oil floor, a depth below which any oil would have been destroyed, occurs at a depth of about 12,800 feet ($R_o = 1.35$ percent). The peak zone for wet gas generation starts at about 10,400 feet at a R_o value of 1.0 percent and the wet gas floor occurs at approximately 15,800 feet ($R_o = 2.0$ percent). Significant quantities of dry gas could start to form at a depth of about 11,900 feet ($R_o = 1.2$ percent) and at vitrinite reflectance values more than 3.0 percent, projected to occur at about 18,900 feet, even dry gas would decompose in the greenschist phase of metamorphism.

The carbon preference index (CPI)--the ratio of odd-numbered to even-numbered straight-chain paraffins in the C_{15+} paraffin-naphthene hydrocarbon fraction--also indicates the degree of thermal maturity. Two different indices, one for C_{21} through C_{27} values and the other for C_{25} through C_{31} values, were calculated (fig. 24). The measurements generally become closer to 1 and to each other in zone C, indicating the greater maturity in this section.

The Amoco data on the percentage of C in kerogen separated from 48 cuttings samples (table 5, fig. 24) provide another qualitative index of maturity for the organic matter in the well. The C percentage shows the

degree of carbonization, a thermal process that results in the generation of volatiles including hydrocarbons (LaPlante, 1974). The generation peak for liquid hydrocarbons for H/C ratios above 0.8 generally occurs between 77 and 85 percent C and most gas generation (H/C ratios between 0.4 and 0.8) takes place between 85 and 89 percent C (Harwood, 1977). The carbonization trend shown in figure 26 for the G-1 well shows a leveling off and possible decrease in C percentage below 12,000 feet, but the kerogen type becomes difficult to identify at this depth which probably represents the top of a thermally mature zone with optimum potential for gas generation.

Detailed analysis of extractable hydrocarbons through C₇ can indicate changes in composition that occur at higher temperatures. These measurements were made by Atlantic Richfield Company (written commun., 1976) on 23 cuttings samples from the G-1 well in order to estimate paleotemperatures at various depths. Ratios of paraffin to naphthene concentrations indicate that early diagenetic generation of cyclopentanes and cyclohexanes, at a temperature of about 170° F, began at a depth of about 6,000 feet. Much higher temperatures were indicated throughout most of zone C, but are unreliable because of the addition of paraffinic hydrocarbons from recycled coal in this section. A maximum paleotemperature of approximately 370° F was determined for samples below 15,000 feet. Other molecular ratios calculated by GeoChem Laboratories, Inc. (1976) also reflect the higher temperatures deeper in the well. The gas wetness (percentage of C₂ through C₄ hydrocarbon components in the light hydrocarbon extract) is listed in table 11 and decreases gradually through the lower part of zone C where dry gas generation should become more prevalent.

Summary and Geochemical Significance

Only zone B of the COST No. G-1 well has significant hydrocarbon-generating potential. Sedimentary rocks in this interval (4,600-6,200 feet) have a moderately high organic content and also contain some biogenic methane. Both oil- and gas-prone kerogen types are present at this depth, but the section is thermally immature and would have to be more deeply buried or

exposed to more intense thermal alteration elsewhere in the Georges Bank basin to have generated commercially important quantities of oil or gas. Older potential source sections may be encountered in this area in rocks which originated in other paleoenvironments or experienced different diagenetic histories.

The COST No. B-2 well, drilled in Baltimore Canyon, penetrated the same three geochemical zones (A, B, and C) seen in the G-1 well. In the B-2 well, zone B is both thicker (4,500 feet) and richer in organic matter, but its sedimentary rocks are also thermally immature with kerogen types that favor gas production. The entire stratigraphic section is considerably thicker in the Baltimore Canyon area than at the G-1 location. Zone C was encountered at a depth 14,000 feet in the B-2 well, and only 2,043 feet were drilled at the bottom of this well compared to the 9,858-foot interval seen in zones C₁, C₂, and C₃ for the G-1 well.

Wells drilled on the Scotian Shelf northeast of Georges Bank show both geochemical similarities and differences when compared to the G-1 well. Amorphous kerogen in the Scotian Shelf wells is abundant only in sediments deposited in an open marine environment (Bujak and others, 1977). The Tertiary and Upper Cretaceous section there is thicker than in the G-1 well, and contains significant amounts of amorphous kerogen but is generally thermally immature. The wide variation in lithologies and in the values of geochemical factors for existing Scotian Shelf wells indicates that the thickness and character of zones B and C will also vary substantially in future wells drilled on Georges Bank.

Table 11--Hydrocarbon concentrations and other geochemical parameters obtained from detailed analysis of well cuttings.

[* Depth given is top of 30-foot interval sampled by well cuttings.

** Insufficient sample of primary vitrinite for analysis.
(c) Caving]

Depth* (feet)	Organic carbon (percent)	C ₁ -C ₄ (ppm)	Gas wetness	C ₄ -C ₇ (ppm)	C ₁₅₊ (ppm)	H/C in kerogen	Vitrinite reflectance (R _o percent)	Percent C in kerogen
Geochemical zone A								
1,690	0.12	590.6	4.8			0.68	0.33	79.4
2,050	.19	128.3	11.9			.77	.34	69.9
2,410	.14	359.5	30.1			.83	.36	70.5
3,490	.15	267.4	6.9			.82	.36 (c)	73.1
3,670	1.48	2,499.5	0.8	27.7				
3,950	.12	1,163.3	2.0			.69	.44	74.4
Geochemical zone B								
4,930	15.16	20,950.2	2.9	22.2	2,307	0.97	0.47	76.5
5,050	3.71	13,994.5	1.6		379	.82	.48	75.4
5,110	1.75	7,254.8	1.4	22.8				
5,290	1.16	4,383.2	1.8	29.7	131	.78	.48	76.9
5,470	1.67	3,594.7	1.6	31.8	134	.77	.45 (c)	77.9
5,650	1.40	1,827.9	2.4	37.6	232	.79	.40 (c)	76.7
5,770	.79	1,061.8	4.9	123.1	40	.71	.54	78.7
5,830	1.38	538.7	6.3					
6,010	1.56	2,032.9	3.2	56.0	83	.70	.45 (c)	78.1
6,130	.71	265.8	6.5		60	.71	.49 (c)	74.3
Geochemical zone C								
6,370	0.48	562.6	14.0	38.5	16	0.70	0.44 (c)	80.2
6,490	.28	775.0	27.2	38.5		.75	.50 (c)	75.1
6,550	.31	484.0	14.1	21.6				
6,730	.96	9,029.1	3.4	40.0		.68	.62	78.7
6,850	.29	603.3	15.7			.67	.66	75.9
6,910	.18	422.4	13.1	30.9				
7,090	.19	425.7	10.7	42.5		.69	.67	77.8
7,270	.34	240.8	38.0	41.0		.66	**	75.5
7,450	.19	227.5	9.3	35.7		.73	**	78.0
7,570	.17	225.5	25.8			.86	**	73.4

Table 11--Hydrocarbon concentrations and other geochemical parameters obtained from detailed analysis of well cuttings--continued

Depth* (feet)	Organic carbon (percent)	C ₁ -C ₄ (ppm)	Gas wetness (percent)	Geochemical zone C--continued			H/C in kerogen	Vitrinite reflectance (R _o percent)	Percent C in kerogen
				C ₄ -C ₇ (ppm)	C ₁₅ + (ppm)				
7,630	0.37	269.5	32.3	32.3					
7,810	.10	272.6	10.2	22.9		0.69	**	77.5	
7,930	.15	123.3	23.1			.87	**	63.4	
7,990	.19	323.1	9.3	22.8			0.71	79.8	
8,170	.16	203.5	7.7	28.4		.64	**	63.3	
8,350	.11	267.9	5.6	19.4		.81	**	80.2	
8,530	.12	115.2	7.1	4.8		.55	**		
8,710	.16	213.0	49.5	5.9			.84	81.1	
8,890	1.36	2,243.6	1.3	12.8		.71	**	81.7	
9,070	.35	934.4	1.7	13.8		.63	**	82.6	
9,250	.46	581.9	3.7	21.0		.68	**	84.2	
9,430	.37	147.7	6.5	26.8		.54	**		
Geochemical zone C ₂									
9,610	0.14	138.5	17.3	18.5		.54	**	82.1	
9,790	.14	179.4	11.0	19.8	61	.54	**	83.2	
9,970	.52	308.5	25.7	51.3		.54	0.97	83.0	
10,150	.89	258.3	42.0	125.0	1,913		**		
10,330	.57	482.9	14.0	46.5	288	.62	1.00	84.6	
10,450	.28	213.3	34.6				1.16		
10,510	.17	313.9	27.0	114.8					
10,690	.21	163.1	21.2	64.4		.56	1.04	84.5	
10,870	.18	56.7	53.4	73.7					
11,050	.24	479.0	22.4	44.8		.65	1.08	84.8	
11,230	.11	1,100.4	34.1	97.9		.70	1.14	82.9	
11,410	.13	493.9	40.3	73.5					
11,590	.44	266.5	38.9	113.8		.58	1.15	83.9	
11,770	.20	274.1	28.1	91.9					
11,950	.38	211.0	24.5	54.9					
12,130	.12	82.5	25.6			.49	**	85.2	

Table 11--Hydrocarbon concentrations and other geochemical parameters obtained from detailed analysis of well cuttings--continued

Depth* (feet)	Organic carbon (percent)	C ₁ -C ₄ (ppm)	Gas wetness (percent)	C ₄ -C ₇ (ppm)	C ₁₅₊ (ppm)	H/C in kerogen	Vitrinite reflectance (R _o percent)	Percent C in kerogen
Geochemical zone C ₃								
12,310	0.21	234.0	24.2	8.5				
12,490	.31	113.4	23.8	10.6		0.45	**	83.8
12,670	.15	382.3	41.6	88.8				
12,850	.12	301.4	31.3	125.7		.59	**	83.1
13,030	.12	409.1	26.1	36.3				
13,210	.13	325.7	28.2	32.9		.62	**	79.1
Geochemical zone C ₄								
13,390	0.08	157.8	23.8	10.1				
13,510	.15	1,053.7	52.9			0.70	1.47	83.2
13,570	.25	443.3	36.2	68.1				
13,750	.58	152.2	34.7	91.6		.58	1.58	79.9
13,810	.52	117.5	39.9					
13,930	.38	225.1	32.0	20.4				
14,110	.42	184.1	26.7	21.4		.53	1.66	80.5
14,290	.44	220.2	31.7	124.1				
14,410	.10	115.7	12.7				1.70	
14,470	.19	129.8	22.1	79.2				
14,590	.14	162.9	18.5	85.7				
14,650	.22	212.4	33.3			.54	1.71	85.1
14,770	.37	222.5	26.8	162.3				
14,950	.12	532.1	12.3	40.1			1.89	
15,130	.15	126.2	29.1	42.8				
15,250	.09	80.6	22.4			.46	1.84	80.5
15,310	.11	135.1	36.3	17.1				
15,490	.42	276.6	39.1	98.0				
15,550	.16	97.4	21.7			.69	**	76.0
15,670	.13	283.2	10.4	59.6				
15,850	.14	121.7	9.2	20.1			**	
16,030	.15	114.3	20.6	44.6			**	

PETROLEUM POTENTIAL

By Edvardas K. Simonis

The four essential requirements for oil and/or gas accumulation are trap, seal, reservoir, and source. In the Georges Bank Basin, the most favorable combination of these requirements is interpreted to occur in the Jurassic and lowermost Cretaceous rocks. The Jurassic section, which ranges in thickness from 10,000 feet in the COST No. G-1 well to more than 16,000 feet in the G-2 well, represents the main phase of basin subsidence. Triassic nonmarine clastic and evaporitic rocks appear to be confined to the deepest, downfaulted parts of the basin. Cretaceous sediments on Georges Bank are widespread but relatively thin (less than 5,000 feet), and are covered by an even thinner (less than 1,000 feet) Cenozoic section.

Traps. Regional USGS seismic reflection data indicate that the most common type of potential traps in the Georges Bank Basin are related to draping of sediments over basement highs (Schlee and others, 1977). Structural closure in most of these drape features tends to be restricted to Jurassic and lowest Cretaceous beds as structural relief decreases upsection and eventually vanishes.

The largest potential drape traps in the Georges Bank Basin probably occur relatively far to the southeast of the COST No. G-1 well. Schlee and others (1977) described such a feature approximately 10 miles south of the COST No. G-2 well. The arch is about 5 miles wide and at a depth of 13,000 feet the structural relief is nearly 1,000 feet.

Farther seaward, a Jurassic to lowest Cretaceous carbonate bank or reef trend is interpreted to be buried under the present continental slope (Grow and others, 1979; Schlee and others, 1979). Even where no vertical closure can be demonstrated, porosity development along this paleo shelf edge may create stratigraphic traps. Patch reefs and oolite banks may form additional traps landward of the Jurassic shelf edge.

Seals. Shales, tight carbonates, and anhydrites are expected to provide adequate seals in most of the Georges Bank Basin. However, at the eastern part of the Georges Bank, along the continental slope, there is evidence that the Upper Jurassic-Lower Cretaceous "reef" trend carbonates have been breached by erosion and, therefore, the seaward flank of the trend is not sealed. Ryan and others (1978) dredged Berriasian (earliest Cretaceous) carbonate platform deposits near Corsair Canyon, and Schlee and others (1979, p. 99) interpreted USGS seismic line 7 as showing that the Upper Jurassic reef platform complex crops out on the slope. Lack of sufficient seals may exist along other parts of the slope, but on the shelf no problems with sealing beds are anticipated.

Reservoirs. In the COST No. G-1 well, the best reservoir characteristics are restricted to the sandstones above 10,000 feet, where core porosity of more than 20 percent and permeability in excess of 100 millidarcies were measured. Reservoir characteristics deteriorate drastically below 10,000 feet where limestone, dolomite, and anhydrite are the dominant lithologies. Similar reduction of porosity and permeability below 10,000 feet occurs in the COST No. G-2 well. Although carbonates in the two COST wells (which were purposely drilled off-structure) appear to be poor reservoir rocks, enhanced porosity development is anticipated on old structurally positive features such as in carbonates overlying basement highs and in reefal carbonate build-ups. On the Scotian Shelf of Canada, in the Middle Jurassic to Lower Cretaceous Abenaki Formation, significant dolomitization and associated leached limestone porosity appear to be restricted to shelf-edge reefal paleo-highs (Eliuk, 1978).

Source. The amount and type of hydrocarbon generated from a source rock depends mainly on three factors: organic richness of the beds, type of organic matter, and stage of thermal maturation of the organic matter. Geochemical data from the COST No. G-1 well (Smith and Shaw, this report) indicate that organically richest rocks occur between 4,600 and 6,200 feet (Lower Cretaceous and Upper Jurassic), but they are thermally immature,

whereas the deeper thermally mature Jurassic rocks are lean in organic matter. Lack of organic-rich rocks within the thermally mature zone in the G-1 well reduces the petroleum potential in vicinity of the well. However, oil- and gas-prone thermally mature source beds are interpreted by Smith (1980) to be present in the COST No. G-2 well, below 13,700 feet, in anhydritic carbonates equivalent to the Middle and Lower Jurassic Iroquois Formation of the Canadian Atlantic Shelf. These source beds could provide hydrocarbons not only to traps in the vicinity of the G-2 well but possibly also, by lateral migration, to traps in the shallower parts of the basin.

Conclusions. In the Georges Bank Basin, the best petroleum potential appears to be in the Jurassic rocks, because the most favorable traps and sufficient thermal maturation for hydrocarbon generation occur within these beds. Lack of organic-rich beds in the thermally mature zone in the COST No. G-1 well, and presence of oil- and gas-prone source beds in the Middle and Lower Jurassic section in the G-2 well indicate that the deeper part of the basin south of the G-1 well is the more prospective one.

The Jurassic and lowest Cretaceous section in the Georges Bank Basin can be divided into two lithostratigraphic units. The upper unit (Middle Jurassic to lowest Cretaceous) is equivalent to the Abenaki Formation and its correlatives of the Canadian Atlantic shelf. The lower unit (Lower to Middle Jurassic) is equivalent to the Iroquois Formation of Canada.

In the COST No. G-2 well, thermally mature source beds appear to be confined mainly to the Iroquois-equivalent anhydritic carbonate section. This section does not contain good reservoir rocks in the G-2 well, but reservoir quality in sandstones and carbonates may improve landward from the well, and porosity in carbonate rocks may have developed near the Jurassic shelf edge.

In the Abenaki-equivalent section, sandstone and carbonate reservoir rocks are expected; dolomite and leached limestone appear to be the most likely reservoirs along the paleo-shelf edge. However, no mature organic-

rich beds in this section were encountered in either the G-1 or the G-2 wells.

Estimates of petroleum potential of the Jurassic rocks in the Georges Bank Basin appear to depend mainly on two questions: 1) are there adequate reservoir rocks in the Iroquois-equivalent section which contains good source beds? and 2) was it possible for hydrocarbons to accumulate in the apparently adequate reservoir rocks of the Abenaki-equivalent section either by vertical migration from the Iroquois source beds or from improved Abenaki source beds in yet undrilled areas? Only additional drilling will answer these questions.

ENVIRONMENTAL CONSIDERATIONS

By Fredrick Adinolfi

Environmental regulations governing the systematic development of the Outer Continental Shelf are provided by law and administered by the USGS. Eighteen oil firms originally nominated 1,927 tracts to be offered for petroleum exploration on Georges Bank. The Department of the Interior then selected 206 tracts for intense environmental study after five coastal States, commercial fishing groups, and environmental organizations responded, pinpointing specific areas they believed should not be leased. Particular geological, environmental, biological, archeological, socioeconomic, and other information was requested from Federal, State, and local governments as well as industry, universities, research institutes, environmental organizations, and members of the general public. This information was published in the draft and final environmental impact statements for the proposed North Atlantic OCS Lease Sale No. 42, prepared by the Bureau of Land Management. This document warned of pollution risk to the environment which would result principally from accidental oil spillage and expressed concern for commercial fishing and pelagic birds. The statement discussed onshore development and offered several alternatives to the lease sale, scheduled for January 31, 1978. After an additional 78 tracts were excluded because of commercial fishing interests and international boundary disputes with Canada, a court injunction blocked the sale in response to lawsuits by the State of Massachusetts, Suffolk County, N.Y., and several environmental groups. The injunction was lifted in February 1979. In April 1979, the Secretary of the Interior decided that a supplement to the final environmental statement would be prepared in response to the court findings on the inadequacy of the original statement (Sale 42 was ultimately held on Dec. 18, 1979; 116 tracts were affected).

In October 1975, Ocean Production Company applied for a permit to drill the COST No. G-1 well Canyon on Georges Bank. The well was to provide industry and the Federal government with geological data necessary

for mineral resource evaluation. The site was selected using seismic data and located off any potential petroleum-trapping structures to minimize the chances of encountering hydrocarbon accumulations. Before approval was granted for the operation, Ocean Production Company was required to conduct a site survey and the USGS released an environmental analysis of the drill site. Environmental considerations included geology, biology, meteorology, oceanography, and archeology, as well as pollution in the event of an oil spill. A high-resolution seismic geophysical survey provided an assessment of potential drilling hazards due to bottom and shallow subbottom conditions. No potential hazards were found in block 79, the location of the drill site. The USGS determined that drilling the COST No. G-1 well would not significantly affect the human and physical environment and, therefore, would not require a separate environmental impact statement. The permit was approved and the well was spudded on April 6, 1976.

Data for the G-1 site survey were collected within 300 feet of the proposed drilling location in about 150 feet of water. Physical and chemical measurements made throughout the water column showed that the water was well mixed, and nearly homogeneous values for temperature, salinity, dissolved oxygen and pH revealed very little change from surface to bottom (Normandeau Associates, written commun., 1975). High-resolution geophysical data, bottom photographs, and grain-size analyses indicate that the bottom sediments are loose, well-sorted, medium-grained quartz sand overlying denser clay and sand (BBN-Geomarine Services Co., 1975). The occurrence of large, migratory sand waves (as much as 50 feet high) with superimposed megaripples and swirling sand indicates the presence of considerable tidal currents. These strong tidal currents are caused by restricted tidal flow in and out of the Gulf of Maine due to the relative positive relief of Georges Bank. These currents result in extensive migration of large volumes of bottom sediment (sand), which is a potential hazard to the stability of drilling platforms (Folger,

1978). Emery and Uchupi (1972) confirm the mobility of bottom sands by noting that sand levels around the legs of radar and weather stations (Texas Towers) deepened enough to weaken the structures, leading eventually to their abandonment on Georges Bank in 1964.

A variety of benthic infaunal organisms (burrowers) were identified in the sandy bottom, primarily amphipoda (sand fleas), polychaeta (marine worms), and decapoda (shrimp). These species are often found in shallow waters associated with sandy beaches and are well adapted to living in a nonstable substrate. Sand-dollars (Clypeastroids) clearly dominated the epifauna at the drill site, living in large colonies with densities as high as 162 per square meter, on the sandy bottom. Hermit crabs were common, and skate and flounder were also identified. The archeologists' report identified no cultural resource features in the area.

The most detrimental impacts on the environment--particularly for fish, wildlife, and New England's rocky shoreline, sandy beaches, marshes, bays, and sounds--would result from a major oil spill. The Massachusetts Institute of Technology oil-spill trajectory model, based on available data on wind and water circulations, computed the trajectory of a hypothetical offshore spill originating at the COST well. The study concluded that there would be very little chance of such a spill reaching shore and if it did the oil would be well-weathered and fragmented into a large number of discrete particles or "blobs." These results were confirmed by a subsequent oil spill risk analysis (Smith and others, 1976) and observations of the Argo Merchant oil spill (Grose and Mattson, 1977).

An oil-spill contingency plan which outlined the equipment available as well as procedures to be followed in the events of an oil spill, was submitted by Ocean Production Company. The drilling rig utilized all required safety and pollution-abatement equipment. The test was drilled in accordance with applicable OCS operating procedures with continuous on-site inspection provided during drilling operations by USGS personnel.

Water pollution resulting from drilling the COST well was minimal. During the first 7 days of drilling, before the initial strings of casing could be cemented in the hole and the blowout preventer and marine riser installed to allow circulation to the drill rig, there was no return of fluids to the platform. Seawater was temporarily clouded as cuttings were dumped directly on the sea floor. Also, there was minor and temporary contamination of seawater and ocean floor near the drill hole from excess cement during casing setting. At a drilling depth of 771 feet below the sea floor, circulation was established between the hole and the drilling platform and only washed cuttings and drilling fluid, containing no oil or toxic materials, were disposed of on the ocean floor. All this material was eventually dispersed by ocean currents.

Mud weight was sufficiently maintained to control all formation pressures and hole conditions to prevent fluids from flowing between formations and leaking out to the surface. Casing and plugging-for-abandonment requirements should preclude any possibility of seepage or contamination at the test site after the completion of drilling. The sea floor was cleared of all obstructions and checked by an observation dive.

SUMMARY AND CONCLUSIONS

The COST No. G-1 well was drilled to total depth of 16,071 feet in the Georges Bank Basin about 89 nautical miles east of Nantucket Island, Massachusetts. The G-1 was drilled by the semisubmersible rig SEDCO J in 157 feet of water at a total cost of about \$8 million. The well was begun on April 6, 1976, and drilling was completed 102 days later on July 17, the first deep well to be drilled in the Georges Bank Basin. Four strings of casing were set during drilling: 30 inch @ 424 feet, 20 inch @ 972 feet, 13 3/8 inch @ 4,022 feet, and 9 5/8 inch @ 10,090 feet.

Five conventional cores were obtained along with 687 sidewall cores, of which 3 conventional and 117 sidewall cores were analyzed for porosity and permeability. Drilling mud consisted of high-gel spud mud to 4,060 feet and lignosulfonate mud for the remainder of the well. Mud weight averaged about 9.0 pounds per gallon to 5,000 feet, then gradually increased to 10.4 at total depth.

The COST No. G-1 drilled through 775 feet of unconsolidated mud, sand, and gravel before drill cuttings could be returned for lithologic and paleontologic examination. Paleocene rocks occur between the first sample, a sidewall core at 1,013 feet, and 1,030 feet. Upper Cretaceous strata were identified from 1,030 to 2,680 feet, Lower Cretaceous from 2,680 to 5,290 feet. Upper Jurassic rocks occur between 5,290 and 10,100 feet, Middle Jurassic from 10,100 to 14,000 feet, and probable Lower Jurassic rocks from 14,000 to 15,600 feet, and probable Upper Cambrian (450-550 million years as dated by geochemical methods) from 15,630 to 16,071 feet, the well's total depth.

The COST No. G-1 well is divided into seven major lithologic sections. Section I, from 1,030 to 6,250 feet consists of Cretaceous and Upper Jurassic light-gray sand, gravel, sandstone, shale and thin beds of dolomite deposited in deltaic and shallow or marginal marine to middle shelf

environments. Section II occurs from 6,250 to 9,940 feet, and contains a sequence of shaly sandstones, gray-green, and reddish-brown shales and thin light-gray and buff limestones and dolomites deposited in tidal flat to shallow marine environments. Section III, 9,940 to 11,900 feet, consists of oolitic limestones, reddish-brown and gray shales, calcareous sandstones, and minor amounts of coal, deposited in tidal flats and shallow carbonate banks. Section IV, 11,900 to 12,360 feet, contains gray, pink, and red sandstones and shales, and gray to buff limestones and dolomites and minor coals deposited in tidal flats and shallow marine waters. Section V, from 12,360 to 13,610 feet, consists of dolomite, sandstone, anhydrite, and shale deposited in sebkha to shallow marine environment and Section VI, 13,610 to 15,600 feet, contains dolomites, sandstones, and reddish-brown and gray shales with minor anhydrite deposited in continental to shallow marine waters. Section VII, from 15,600 to 16,071 feet, consists of metadolomites, metaquartzites, phyllite and gneiss which are Paleozoic basement rocks.

Seven different types of wireline geophysical ("electric") logs were run in the G-1 well to obtain petrophysical data (formation porosity, permeability, lithology, fluid content, and dip calculation). In addition, three types of mud logs--lithology log, drilling pressure log, and pressure analysis log--were obtained. Log analysis indicated a total of 4,230 feet of porous rock of reservoir potential (greater than 8% pore space) in the well, of which 99% occurs above 10,000 feet. Below this depth, the pore spaces become increasingly filled with calcite, quartz, and clays. By depth interval, thicknesses of porous zones are 681 feet averaging 16.3 percent porosity between 973 and 4,050 feet depth, 638 feet averaging 16.1 percent between 4,050 and 5,200 feet depth, 2,666 feet averaging 12.6 percent between 5,200 and 9,940 feet depth, 93 feet averaging 8.6 percent between 9,940 and 11,970 feet depth, and 152 feet of porosity averaging 8.2 percent between 11,970 and 15,980 feet depth. The best combination of potential reservoir rocks and sealing beds occurs between 5,200 and 9,940 feet.

Dips of the bedding planes range from 1 to 4 degrees southeast to about 15,000 feet, below which they become irregular with a range of 8-40 degrees from northwest to southeast.

A thermal gradient of 1.17° F per 100 feet was calculated for the well, slightly lower than the 1.2 to 1.3° F/100 feet values of other western Atlantic basins. The calculated thermal gradient is close to a gradient derived from vitrinite reflectance data, indicating past and present gradients are very similar.

A pressure gradient of .438 psi/foot was calculated for the well from a series of formation tests. The gradient is similar to that in other Atlantic wells but lower than the average gradient for the Gulf of Mexico.

Velocity data from the Sonic Log and Uphole Velocity Survey for the well, compared to velocities from a nearby seismic record, indicate that most of the strong seismic reflectors on records in the well's vicinity relate to bases of thick shales or tops of sandstones in the upper part of the well, and to dolomite - anhydrite interfaces in the lower part.

Geochemical data from the G-1 indicate that the organically richest rocks occur between 4,600 and 6,200 feet (Lower Cretaceous and Upper Jurassic), but they are thermally immature, whereas the deeper, thermally mature Jurassic rocks are lean in organic matter. The kerogen types in this interval are capable of both oil and gas generation, if subjected to higher temperatures. The best potential petroleum reservoirs occur in the sandstones above 10,000 feet, where core and log porosities of 20 percent or more and permeabilities in excess of 100 millidarcies are common. Below 10,000 feet, porosities and permeabilities are reduced drastically as limestone, dolomite, shale, and anhydrite become the predominant lithologies.

SELECTED REFERENCES

- Amato, R. V. and Bebout, J. W., 1978, Geological and Operational Summary, COST No. GE-1 Well, Southeast Georgia Embayment Area, South Atlantic OCS, United States Geological Survey Open-File Report 78-668, 122 p.
- Amato, R. V. and Simonis, E. K., 1979, Geologic and Operational Summary, COST No. B-3 Well, Baltimore Canyon Trough Area, Mid-Atlantic OCS, United States Geological Survey Open-File Report 79-1159, 118 p.
- BBN-Geomarine Services Co., 1975, COST wellsite G-1, Georges Bank, engineering geology interpretation of high-resolution geophysical data: Houston, Texas, 11 p.
- Burk, C. A., and Drake, C. L., eds., 1974, Geology of continental margins: New York, Springer-Verlag, 1,009 p.
- Bujak, J. P., Barss, M. S., and Williams, G. L., 1977, Offshore east Canada's organic type and color and hydrocarbon potential: Oil and Gas Journal, v. 75, no. 14, p. 198-202; no. 15, p. 96-100.
- Core Laboratories, Inc., 1976, Core studies, C.O.S.T. Atlantic well No. G-1, Georges Bank, Offshore Atlantic Ocean: Dallas, Texas, 153 p.
- Davey, R. J., and Verdier, J. P., 1974, Dinoflagellate cysts from the Aptian type sections at Gargas and La Bedoule, France: Paleontology, v. 17, pt. 3, p. 623-653. Dow, W. G. 1977, Kerogen studies and geological interpretations: Journal of Geochemical Exploration, v. 7, no. 2, p. 79-99.
- Drake, C. L., Ewing, J. I., and Stockard, H., 1968, The continental margin of the eastern United States: Canadian Journal of Earth Science, v. 5, no. 4, p. 993-1010.
- Drake, C. L., Ewing, Maurice, and Sutton, G. H., 1959, Continental margins and eosynclines--The east coast of North America north of Cape Hatteras, in Aherns, L.H., and others, eds., Physics and chemistry of the earth, v. 3: New York, Pergamon, p. 110-198.
- Eliuk, L. S., 1978, The Abenaki Formation, Nova Scotia, Canada--a depositional and diagenetic model for a Mesozoic carbonate platform: Bulletin of Canadian Petroleum Geology Bulletin, v. 26, no. 4, p. 424-514.

- Emery, K. O., and Uchupi, Elazar, 1972, Western North Atlantic Ocean--
Topography, rocks, structure, water, life, and sediments: American
Association of Petroleum Geologists Memoir 17, 532 p.
- Evitt, W. R., ed., 1975, Proceedings of a forum on dinoflagellates:
American Association of Stratigraphic Palynologists, Contribution
Series no. 4, 76 p.
- Folger, D. W., 1978, Geologic hazards on Georges Bank: An overview: Geo-
logical Society of America Abstracts with Programs, v. 10, no. 1,
- Fry, C. E., 1979, Geothermal gradient, in Amato, R. V., and Simonis, E. K.,
eds., Geologic and Operational Summary, COST No. B-3 well, Baltimore
Canyon Through Area, Mid-Atlantic OCS: U.S. Geological Survey Open-
File Report 79-1159, p. 64-65.
- GeoChem Laboratories, Inc., 1976, Hydrocarbon source facies analysis, C.O.S.T.
Atlantic G-1 well, Georges Bank, offshore Eastern United States:
Houston, Texas, 10 p.
- Gibson, T. G., 1970, Late Mesozoic-Cenozoic tectonic aspects of the Atlantic
coastal margin: Geological Society of America Bulletin, v. 81,
p. 1813-1822.
- Grose, P. L., and Mattson, J. S., 1977, The Argo Merchant oil spill: a pre-
liminary scientific report: National Oceanic and Atmospheric Administra-
tion Environmental Research Laboratories, 129 p.
- Grow, J. A., Mattick, R. E., and Schlee, J. S., 1979, Multichannel seismic
depth sections and interval velocities over continental shelf and upper
continental slope between Cape Hatteras and Cape Cod, in Watkins, J. S.,
Montadert, Lucien, and Dickerson, P. W. eds., Geological and geophysical
investigations of continental margins: American Association of Petro-
leum Geologist Memoir 29.
- Harwood, R. J., 1977, Oil and gas generation by laboratory pyrolysis of kerogen:
American Association of Petroleum Geologists Bulletin, v. 61, no. 12,
p. 2082-2102
- International Biostratigraphers, Inc., 1976, Biostratigraphy of the C.O.S.T.
G-1 Georges Bank test: Houston, Texas, 16 p.

- King, L. H., and MacLean, B., 1975, Geology of the Scotian Shelf and adjacent areas: Canada Geological Survey Paper 74-23, p. 22-53.
- Landes, K. K., 1967, Eometamorphism and oil and gas in time and space: American Association of Petroleum Geologists Bulletin, vol 51, No. 6, p. 828-841.
- LaPlante, R. E., 1974, Hydrocarbon generation in Gulf Coast Tertiary sediments: American Association of Petroleum Geologists Bulletin, v. 58, no. 7, p. 1281-1289.
- McIver, N. L., 1972, Cenozoic and Mesozoic stratigraphy of the Nova Scotia shelf: Canadian Journal of Earth Science, v. 9, no. 1, p. 54-70.
- Maher, J. C., 1971, Geologic framework and petroleum potential of the Atlantic Coastal Plain and Continental Shelf: U.S. Geological Survey Professional Paper 659, 98 p.
- Mattick, R. E., Foote, R. Q., Weaver, N. L., and Grim, M. S., 1974, Structural framework of United States Atlantic Outer Continental Shelf north of Cape Hatteras: American Association of Petroleum Geologists Bulletin, v. 58, no. 6, p. 1179-1190.
- Murray, G. E., 1961, Geology of the Atlantic and Gulf Coastal Province of North America: New York, Harper, 692 p.
- Perry, W. J., Minard, J. P., Weed, E. G. A., Robbins, E. I., and Rhodehamel, E. C., 1975, Stratigraphy of the Atlantic continental margin of the United States north of Cape Hatteras--brief survey: American Association of Petroleum Geologists Bulletin, v. 59, no. 9, p. 1529-1548.
- Pusey, W. C., III, 1973, The ESP-Kerogen method: How to evaluate potential gas and oil source rocks: World Oil, v. 176, no. 5, p. 71-75 (April 1).
- Robbins, E. I., and Rhodehamel, E. C., 1976, Geothermal gradients help predict petroleum potential of Scotian Shelf: Oil & Gas Journal, v. 74, no. 9, p. 143-145 (March 1).
- Rona, P. A., 1973, Relations between rates of sediment accumulation on continental shelves, sea-floor spreading, and eustasy inferred from central North Atlantic: Geological Society of America Bulletin, v. 84, no. 9, p. 2851-2872.

- Ryan, W. B. F., Cita, M. B., Miller, E. L., Hanselman, D., Hecker, B., and Nibbelink, M., 1978, Bedrock geology in New England submarine canyons: *Oceanologia Acta*, v. 1, no. 2, p. 233-254.
p. 47-93.
- Schlee, J. S., Behrendt, J. C., Grow, J. A., Robb, J. M., Mattick, R. E., Taylor, P. T., and Lawson, B. J., 1976, Regional geologic framework off northeastern United States: *American Association of Petroleum Geologists Bulletin*, v. 60, p. 926-951.
- Schlee, J. S., Dillon, W. P., and Grow, J. A., 1979, Structure of the continental slope off the eastern United States, in Doyle, L. J., and Pilkey, O. H., eds., *Geology of continental slopes: Society of Economic Paleontologists and Mineralogists Special Publication No. 27*, p. 95-117.
- Schlee, J. S., Martin, R. G., Mattick, R. E., Dillon, W. P. and Ball, M. M., 1977, *Petroleum geology in the United States Atlantic-Gulf of Mexico margins: Exploration and economics of the petroleum industry; new ideas, methods, developments*, v. 15, New Yorks Matthew Bender and Co., New York, p. 47-93.
- Schlee, J. S., Mattick, R. E., Taylor, D. J., Girard, O. W., Rhodehammel, E. C., Perry, W. J., and Bayer, K. C., 1975, Sediments, structural framework, petroleum potential, environmental conditions, and operational considerations of the United States North Atlantic Continental Shelf: U.S. Geological Survey Open-File Report 75-353, 179 p.
- Schultz, L. K., and Grover, R. L., 1974, *Geology of Georges Bank Basin: American Association of Petroleum Geologists Bulletin*, v. 58, p. 1159-1168.
- Sheridan, R. E., 1974a, Conceptual model for the block-fault origin of the North American Atlantic continental margin geosyncline: *Geology*, v. 2, p. 465-468.
- _____ 1974b, Atlantic continental margin of North America, in Burk, C. A., and Drake, C. L., eds., *Geology of continental margins: New York, Springer-Verlag*, p. 391-407.

- Sherwin, D. F., 1973, Scotian Shelf and Grand Banks, in McCrossan, R. G., ed.,
Future petroleum provinces of Canada--Their geology and potential:
Canadian Society of Petroleum Geologists Memoir 1, p. 519-559.
- Smith, H. A., 1975, Geology of the West Sable structure: Canadian Petroleum
Geology Bulletin, v. 23, no. 1, p. 109-130.
- Smith, M. A., Amato, R. V., Furbush, M. A., Pert, D. M., Nelson, M. E.,
Hendrix, J. S., Tamm, L. C., Wood, G. J., and Shaw, D. R., 1976,
Geological and operational summary, COST No. B-2 well, Baltimore
Canyon Trough area, Mid-Atlantic OCS: U. S. Geological Survey,
Open-File Report 76-774, 79 p.
- Smith, M.A., 1980, Geochemical analysis, in, Geologic and Operational
summary, COST No. G-2 well, Georges Bank area, North Atlantic OCS:
U. S. Geological Survey Open-File Report, 80-269, p. 77-99.
- Smith, R. A., Stack, J. R., and Davis, R. K., 1976, An oil spill risk
analysis for the Mid-Atlantic Outer Continental Shelf lease area:
U. S. Geological Survey Open-File Report 76-451, 24 p.
- Staplin, F. L., 1969, Sedimentary organic matter, organic metamorphism,
and oil and gas occurrence: Canadian Petroleum Geology Bulletin,
v. 17, no. 1, p. 47-66.
- Stewart, H. B., Jr., and Jordan, G. F., 1964, Underwater sand ridges on
Georges Shore, in Miller, R. L., ed., Papers in marine geology, Shepard
commemorative volume: New York, Macmillan, p. 102-114.
- Tamm, L. C., Electric log interpretations, in Amato, R. V. and Bebout, J. W.,
1978, eds., Geological and operational summary, COST No. GE-1 Well,
Southeast Georgia Embayment Area, South Atlantic OCS: U. S. Geological
Survey Open-File Report 78-668, p 61-75.
- Tschudy, R. H., 1973, Complexiopollis pollen lineage in Mississippi embayment
rocks: U.S. Geological Survey Professional Paper 743-C, p. C1-C15.
- Uchupi, Elazar, and Emery, K. O., 1967, Structure of continental margin off
Atlantic coast of United States: American Association of Petroleum
Geologists Bulletin, v. 51, p. 223-234.
- Weed, E. G. A., Minard, J. P., Perry, W. J., Jr., Rhodehamel, E. C., and
Robbins, E. I., 1974, Generalized pre-Pleistocene geologic map of the

- northern United States Atlantic continental margin: U.S. Geological Survey Miscellaneous Investigations Map I-861, scale 1:1,000,000.
- Williams, G. L., 1974, Dinoflagellate and spore stratigraphy of Mesozoic-Cenozoic, offshore eastern Canada: Regional Geology, v. 2, Canada Geological Survey Paper 74-30, p. 107-146.
- Williams, G. L., and Brideaux, W. W., 1975, Palynologic analyses of upper Mesozoic and Cenozoic rocks of the Grand Banks, Atlantic continental margin: Canada Geological Survey Bulletin 236, 163 p.

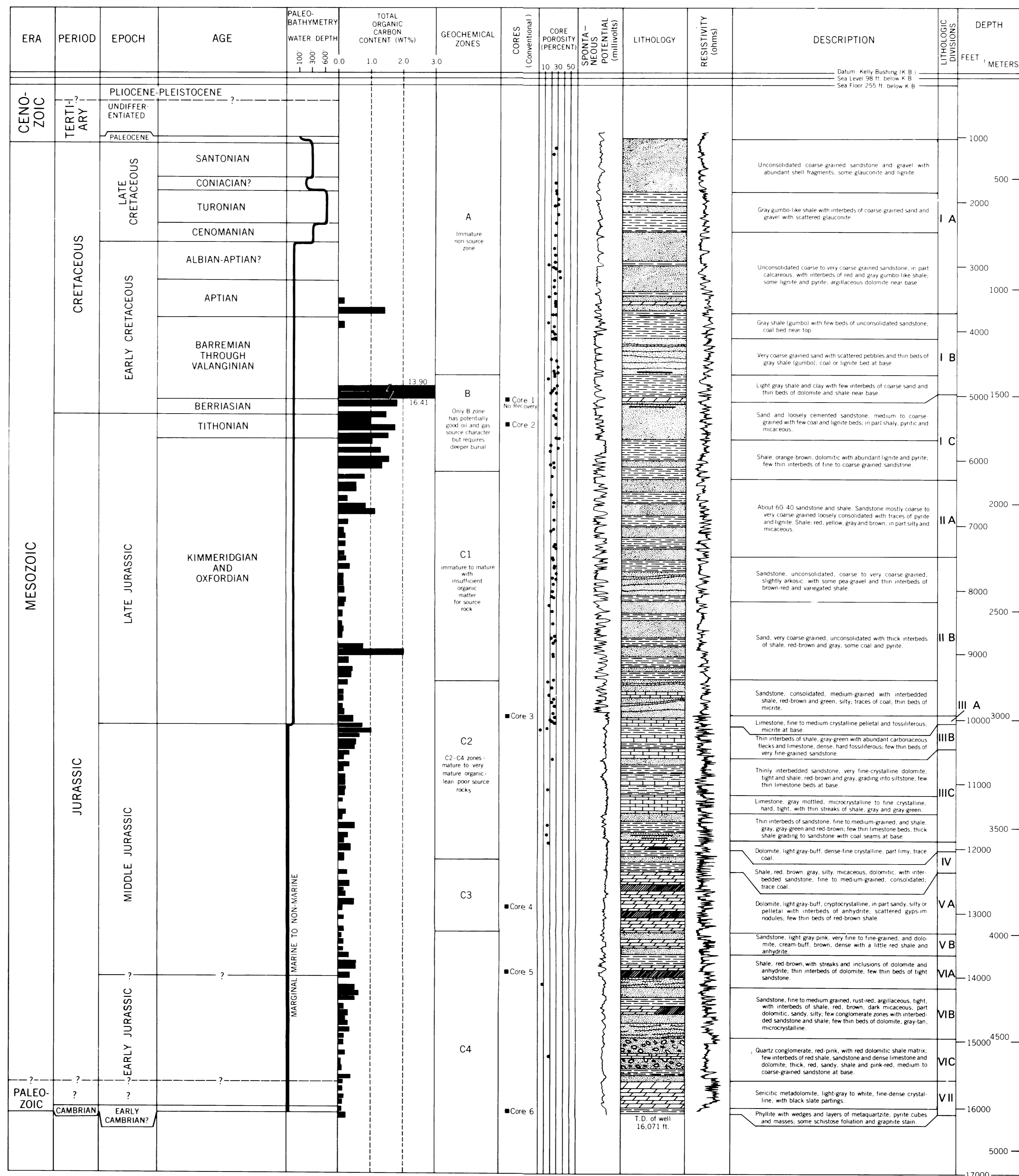

Plate 1. STRATIGRAPHIC COLUMN AND SUMMARY CHART OF GEOLOGIC DATA, COST NO. G-1 WELL, U.S. NORTH ATLANTIC CONTINENTAL MARGIN

DEPTH (FEET) | TIME (SECONDS)

COST NO. G-1

UNITED STATES DEPARTMENT OF THE INTERIOR
GEOLOGICAL SURVEY

U.S.G.S LINE 77-1

OPEN-FILE REPORT 80-268
PLATE 2

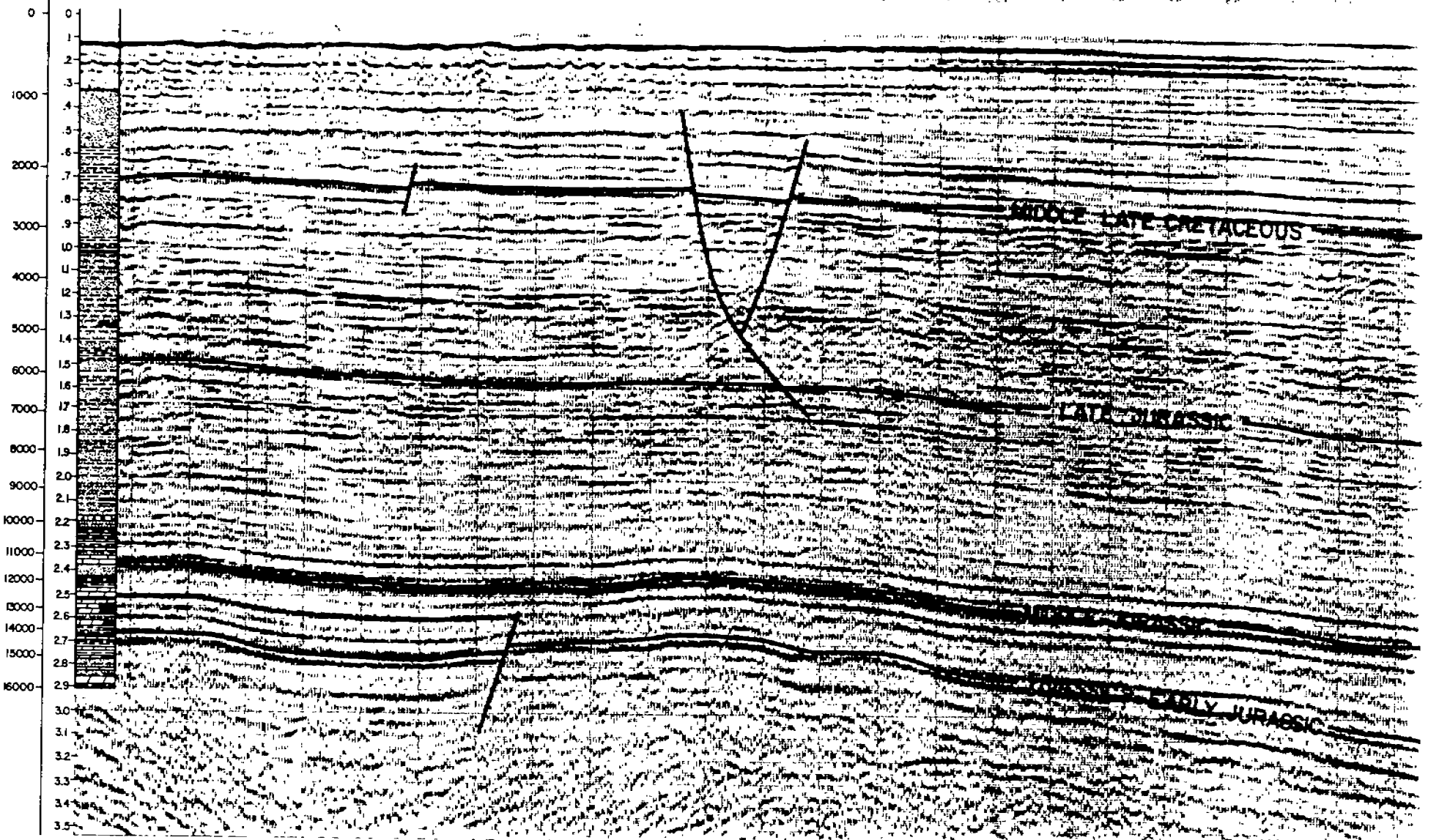

PLATE 2. PORTION OF U.S.G.S. SEISMIC LINE 77-1 SHOWING RELATIONSHIP OF COST NO. G-1 MAJOR LITHOLOGIC UNITS TO SEISMIC REFLECTORS